

جامعة نيويورك أبوظبي

 NYU | ABU DHABI



AY 20-21 UNDERGRADUATE RESEARCH REPORT



AY 20-21 UNDERGRADUATE RESEARCH REPORT

OFFICE OF UNDERGRADUATE RESEARCH
NYU ABU DHABI

Saadiyat Island, PO Box 129188
nyuad.undergraduateresearch@nyu.edu
nyuad.nyu.edu/undergrad-research



Since its inception, NYU Abu Dhabi has been at the forefront of encouraging and promoting transformative educational experiences through integrating research and creative activities within a student's academic life. Students are provided with a breadth of research opportunities embedded within the curriculum, alongside directed research opportunities. Undergraduates have the opportunity to work with NYUAD faculty, who serve as mentors, collaborators, and role models to encourage ingenuity and support students in turning their ideas into solid learning objectives and outcomes.

Undergraduate research at NYUAD spans the full range of disciplines, from scientific research in a laboratory to film production and screenings. This report showcases some of the excellent undergraduate research work which has taken place during the academic year 2020-2021 and in summer 2021. These student research experiences have been paramount to fostering critical thinking, analytical and technical skills through hands-on learning, whilst also serving as a platform to balance collaborative and individual work. The breadth of these research experiences, which span the 4-years of undergraduate studies, allow our students to determine their areas of interest and to explore post-graduation plans.

While this report celebrates the accomplishments of our undergraduate researchers, it would be amiss to not highlight the remarkable dedication of faculty and researchers at NYUAD and beyond. Their commitment to supporting a blended working model, managing online collaborations whilst also supervising students in-person, has made the accomplishments showcased within this report possible.

A special note of appreciation is extended to the Office of Undergraduate Research Faculty Committee, who advise on the office's programs, guidelines and new initiatives, and review research funding requests and fellowship applications. The Committee comprises of Andrea Macciò, Sarah Paul, Olivier Bochet and Pradeep George. I would also like to extend my gratitude to Vice Provost and Associate Vice Chancellor of Global Education and Outreach Carol Brandt, who oversees the development of NYUAD's summer programs of experiential learning, serving more than 500 students in internships and undergraduate research.

Sincerely,

FARHANA GOHA

Assistant Director, Office of Undergraduate Research



CONTENTS

Undergraduate Research Programs at a Glance	5
AY 20-21 Undergraduate Research Highlights	7
Arts and Humanities	7
Engineering	15
Science	26
Social Science	37
Interdisciplinary	42
Research Fellowship Program	45
Faculty Supervisors	52



UNDERGRADUATE RESEARCH PROGRAMS AT A GLANCE

SUMMER UNDERGRADUATE RESEARCH PROGRAM

Offers competitive grants to support students across the divisions, who have secured summer research positions. Students may work on independent research projects or join existing faculty research projects.

95

FULL-TIME SUMMER RESEARCH POSITIONS

POST-GRADUATION PRACTICAL TRAINING PROGRAM

Allows faculty to appoint NYUAD seniors graduating in May to work full-time on faculty research projects in the summer following their graduation.

120

RESEARCH POSITIONS

CONFERENCE GRANTS

Students may apply for conference grants to enable them to present their research and creative works at conferences and exhibitions.

9

CONFERENCE GRANTS AWARDED

STUDENT ASSISTANTSHIP PROGRAM

Provides students the opportunity to earn money through part-time, hourly jobs with NYUAD faculty.

384

RESEARCH POSITIONS

VISITING STUDENT SUMMER UNDERGRADUATE RESEARCH PROGRAM

Offers the opportunity for NYU New York, NYU Shanghai, and external undergraduate students studying in local universities within the UAE to take part in research during the summer, supervised by NYUAD faculty members and funded by the Office of Undergraduate Research.

37

STUDENTS ENROLLED

INTERNSHIPS FOR UNDERGRADUATE STUDENTS

An opportunity for external undergraduate students based in the UAE who wish to take part in a research internship at NYUAD during the academic year, and have a demonstrated interest in research and academia.

8

RESEARCH INTERNSHIPS TOOK PLACE

POST-GRADUATION RESEARCH FELLOWSHIP PROGRAM

Retains outstanding academic talent within the region by supporting a select cohort of exceptional NYUAD graduating seniors to be awarded a prestigious one-year research fellowship at NYUAD.

11

RESEARCH FELLOWSHIPS AWARDED



ARTS AND HUMANITIES



Class of 2022

RAYNA LI

Major
Art and Art History
Faculty Supervisors
Alia Yunis and Robert Parthesius

ASSEMBLING FRAGMENTS OF A GLOBAL PAST FOR A PROSPECTIVE WORLD HERITAGE SITE: A CASE STUDY OF JINGDEZHEN'S PATH TO UNESCO INSCRIPTION

Jingdezhen, a small town in southern China, is famous for its historic role in the production of ceramics. Today, the city's many monuments are being prepared for future inscription on the prestigious World Heritage List, but what the locals consider to be the city's quest to World Heritage is not without problems.

My research project builds on my interest in heritage studies, art history, and anthropology, and it examined the ways in which diverse voices and understandings of Jingdezhen's porcelain heritage can enhance or challenge the authorized narratives surrounding this prospective World Heritage Site. This project will also be part of a student essay anthology themed around 'heritage in the contact zone', in which student researchers at Dhakira Center for Heritage studies explore and critically examine what it means for heritage sites to be both shared and contested, as well as both locally-grounded and universally-resonant.

My research used oral history interviews and discourse analysis as its main methods, and it sought to make visible the local stakeholders' experience living and working on this 'heritage site in the works'. Over a period of 25 days in July, I conducted fieldwork in Jingdezhen and interviewed various heritage narrators both from the civil society and the academic profession, such as young entrepreneur-artists, the so-called 'Jingdezhen Drifters', antique dealers, university professors, and heritage property managers. With these narrative accounts and first-hand experiences, I strive to expose the central issue both in Jingdezhen's current nomination and UNESCO's Eurocentric discourse.



Rayna collects oral history narratives from an artist-entrepreneur over a casual tea ceremony



First-hand experience of Jingdezhen's open-air markets and the city's rich antiquarian culture



Rayna interviews a local artist about her work at an open-air art and craft fair



A porcelain studio owner takes Rayna on a visit to Jingdezhen's weekly "Ghost Market". While examining antiques sold at a street-side stall, they discussed the impact of 18th-century Chinese export porcelain on Jingdezhen's current cultural identity

Class of 2021

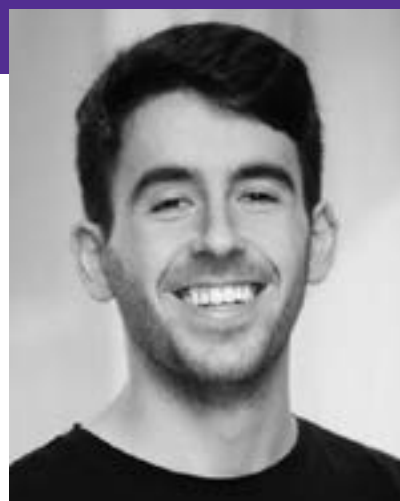

CHRISTOS PLACHOURAS

Major
Computer Science and Music
Faculty Supervisor
Carlos Guedes

ORGANIZATION AND DISTRIBUTION OF CULTURE- SPECIFIC MUSIC CORPORA

I worked on the Eisenberg Collection, a collection of commercial music recordings collected primarily from the Kenyan coast but more generally in Swahili-speaking regions in East Africa, as well as the NYUAD Library's music collection of digitized music recordings from the Arab Mashriq. While these two collections contain fascinating cultural and historical insights about these regions, they have been inaccessible to researchers outside of NYU. My task was preparing both collections to become openly accessible, easier to use and understand by researchers that are interested in performing computational tasks on them.

Understanding the exact scope, purpose, value, coverage, and representativeness of the collection was critical, both for their organization and for providing researchers a clear understanding of potential bias in the data. A structural hierarchy for the digital recordings and their associated metadata was devised, followed by a storage hierarchy for certain components of the collections like the recordings themselves but also the associated code and tools. Subsequently, repositories and tools for accessing and downloading the formatted data were made, along with a number of scripts to aid computational tasks and facilitate reproducible experiments on the corpora.

Class of 2021



VINCE NGUYEN

Major
Interactive Media
Faculty Supervisor
Carlos Guedes and Leonid Kuzmenko

DEVELOPING A VR INTERFACE FOR VISUALIZING AND BROWSING MUSIC COMPENDIUM

This VR research project is a self-exploratory data visualization in an immersive virtual reality experience of the Arab Mashriq and Western Indian Ocean music compendium. Building upon the existing project from the 2019 paper published by the Music and Sound Cultures research group at NYU Abu Dhabi, I developed a VR experience that allows users to freely navigate through the three dimensional space to explore the similarities and/or differences among over ten thousand sounds analyzed by different algorithms from regions in the trans-Indian Ocean world. This research project was made possible using the state-of-the-art Unreal Engine and Oculus Quest, both serving to create a realistic and navigable VR environment.



A VR bird eye view of the Middle Eastern - Indian Ocean regions from which users can dive deep into the collection of music and sound clips unique to a certain location

Class of 2023



ADI BAURZHANULY

Major
Economics
Faculty Supervisor
Fiona Kidd

MAKING CONNECTIONS: DRESS IN SOGDIAN SAMARKAND, 6TH CENTURY BCE - 4TH CENTURY CE

I assisted Professor Kidd in developing content for her book. The aim of the book is to use visual evidence to understand how inhabitants of the Samarkand region of Sogdiana (modern Uzbekistan) negotiated and situated themselves in the increasingly connected world of pre-Islamic Central Asia. We focused on representations and material remains of clothing associated with this region, because clothing is a critical vehicle to non-verbally convey important social information about individual and group identities. Clothing communicates, but no written or spoken language is required to read the message. The high visibility of costume ensures that it is a barometer for group and individual affiliations at various levels, from, in the context of this book, the local Samarkand region, to the global greater Iranian world. Non-verbal communication is important in linguistically and culturally plural contexts such as Central Asia, whose location has ensured that exchange and cross-cultural communications facilitated by symbiotic agro-pastoral, and mobile Saka/Scythian populations since at least the Bronze Age were intrinsic to its world view. In these cases, clothing provides an organic platform to express identity, belonging, and difference. In a connected world, it is especially important for scholars because it reflects valuable insights on society that are often overlooked - including group identities, cultural affiliations and linkages, and space.



Class of 2021

NICCOLÒ ACRAM CAPPELLETTO

Major
Art and Art History
Faculty Supervisor
David Wrisley

THE PARIS BIBLE PROJECT

I worked on the Paris Bible Project (parisbible.github.io) during the academic year as a student research assistant and then, became a full-time assistant during my PPTP. The research focuses on the production and diffusion of medieval Latin Bible manuscripts in Europe from the 12th and 13th centuries until their present distribution in (digital) libraries all over the world. This project was born in the context of the pandemic and gave me the possibility to delve into different trajectories of digital research while physical research was reduced to the minimum. I gained new skills, I learnt new software and platforms (Transkribus, Notion, Tropy, among others), and I developed interesting and original research, which culminated in an article to be published in January.

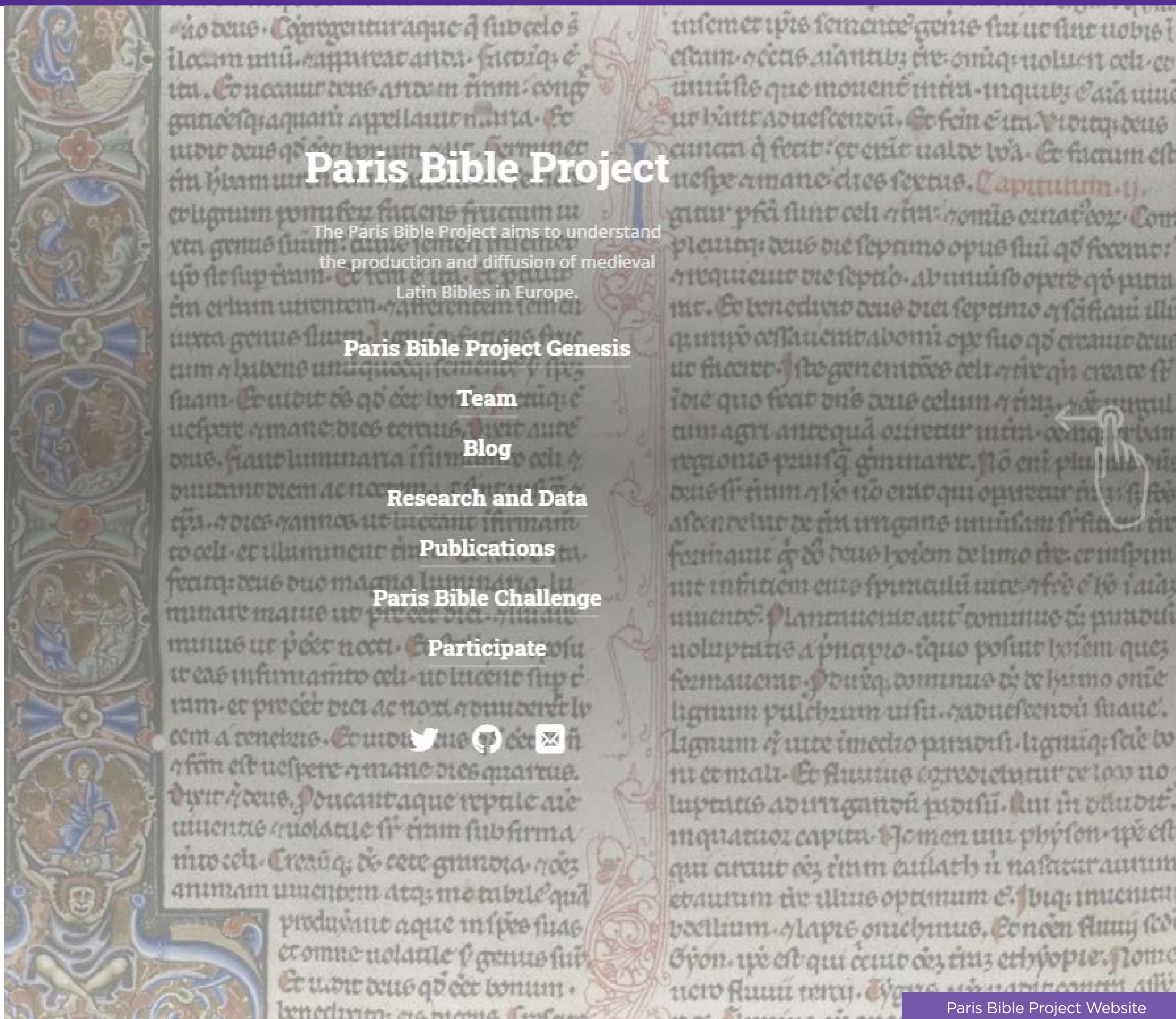

“ Working in Digital Humanities represented an opportunity to dive deep into an interdisciplinary approach that required the combination of humanities (Latin and Art History) with the computational methods of research. I aimed to learn as much as possible from every aspect of the work but most importantly, the teamwork with professor Wrisley and researcher Estelle Guéville made this experience valuable and incredibly positive. I concluded the collaboration with a rich baggage of experiences and a new network of research.



Class of 2024

SARRA GHODBANE

Major
Economics
Faculty Supervisor
David Wisley

Class of 2023



DUŠAN POPOV

Major
Political Science and Economics
Faculty Supervisor
Martin Klimke

DIGITAL HUMANITIES PROJECTS

I spent my freshman year working on digitization projects that ranged from training AI models for character recognition to interpreting and analyzing translations of old Arabic texts. Other projects involved historical research, archiving, and building time capsules of cities by doing research of materials, phonebooks, texts, pictures and films for the purpose of spatial mapping.



Archived photo of a small business in Tunis in the 1960s

“ I loved the thrill of discovery and of expanding my skill set outside of my academic sphere. Contributing to laying the foundation for other scholarly purposes and knowing that your work is meaningful and useful to others is truly fulfilling too.

THE NUCLEAR CRISIS PROJECT - COLD WAR CULTURES AND THE POLITICS OF PEACE AND SECURITY, 1975 - 1990

I took part in a research assistantship on the Nuclear Crisis Project. The research project analyzed sources detailing the contributions of four female activists regarding the struggle against nuclear proliferation during the Cold War. A variety of primary and secondary historical sources were studied, including books, journals, records, news sources and letters from the late seventies and early eighties. Their goal was to show the effects of harm that the mere presence of nuclear weapons had on strikingly different societies. Through grassroots activism, public opinion on nuclear weapons changed, and emergent political and social movements with an ever more far-reaching agenda were given new energy, in both the East and West.

The research, furthermore, revealed how crucial female leadership was for the success of the movement, expanding its mobilization potential, which ultimately contributed to mounting enormous pressure on leaders of nuclear powers to give up on the procurement of nuclear weaponry, and make our world a safer place. Scientific contributions of Dr. Helen Caldicott and her associated teams, coupled with the activism of leading political figures like Petra Kelly, were crucial to the détente in the Cold War, and reduced the risk of a deadly nuclear conflict.



Class of 2021

TOM ABI SAMRA

Major
Literature and Creative Writing
Faculty Supervisor
Salwa Mikdadi

BEYOND THE BINARY: CONTEXTUALIZING THE FIGURATION / ABSTRACTION DEBATE IN THE 1960s ART SCENE IN BEIRUT

As a PPTP student with the alMawrid Arab Center for the Study of Art, I conducted research in the archives of the Nicolas Sursock Museum in Beirut, Lebanon. My research revolved around the question of abstraction in the art scene in 1960s Beirut. Put simply, some artists and critics considered abstraction to be a western aesthetic import, while others welcomed all sorts of aesthetic innovations—whether western or not. However, most research does not look beyond this binary. Therefore, I mined the archive for other debates that have little or nothing to do with the question of abstraction, in order to nuance our understanding of the arts scene at the time.

I placed the artistic debates of the time within their larger intellectual and cultural contexts, including debates in literature, philosophy, and history. One particularly important debate—currently overshadowed in art historical research by the question of abstraction—was that of “commitment” (engagement in French, iltizām in Arabic), that is, the question of whether art should be explicitly political or not. In the archive, I looked for critical positions that reflect a concern with iltizām, considering how these critical positions related, if at all, to the debate on abstraction.



Archives studied at the Nicolas Sursock Museum in Beirut, Lebanon



Tom Abi Samra was invited to present another research project as part of the panel “Communication Mediation in the Digital Age” at the 54th Annual Meeting of the Middle East Studies Association (MESA) on October 5, 2020.

Class of 2021

KILLIAN DUMONT

Major
Social Research and Public Policy
Faculty Supervisors
Mark Swislocki and Sophia Kalantzakos



VISUAL STORYTELLING SERIES FOR THE GEOPOLITICS AND ECOLOGY OF HIMALAYAN WATER PROJECT

I worked with a filmmaker and journalist to create a three part visual storytelling series called “The Melting Mountains” for the Geopolitics and Ecology of Himalayan Water project. My work included research to select three relevant topics related to water and climate change in the Himalaya: migration, gender, and tourism. Within these three topics, I interviewed 17 experts across the Himalayan region in order to discover the human impacts of the climate crisis, and meet the people working to combat it. From these interviews, I pulled together quotes, news and stock footage, drafted storyboards, and ultimately helped to create the three 7-minute videos.

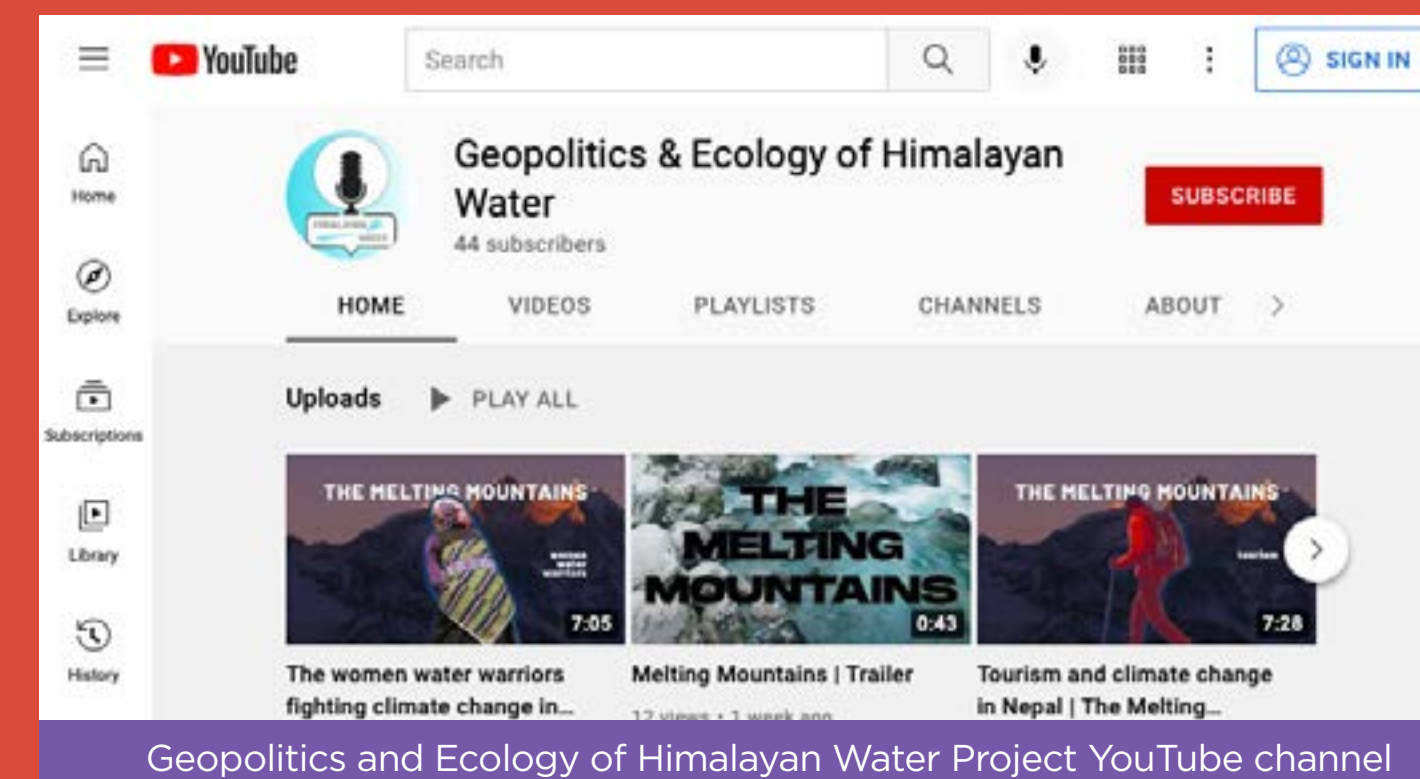

HUMANITIES RESEARCH FELLOWSHIP FOR THE STUDY OF THE ARAB WORLD

The Humanities Research Fellowship for the Study of the Arab World aims to help create an energetic, multi-faceted research environment for the Humanities and the study of the Arab world at NYUAD's campus. This includes its rich literature and history, its cultural and artistic heritage, and its manifold connections with other cultures.



NYU Shanghai | Class of 2022

MAHDER TAKELE TESHOME

Major
Religion and Language

Faculty Supervisors
Taneli Kukkonen, Chris Ocker and Jan Loop

University of Sorbonne Abu Dhabi | Class of 2021



SHAMMA ALMHEIRI

Major
Sociology and Philosophy

Faculty Supervisor
Saqer Almarri

RECOGNIZING RELIGIONS PROJECT

The Recognizing Religions project aims to highlight the interactions, habits, and concepts of research on religions to understand how these viewpoints have influenced their perception. It is executed through online seminars where members present their work on Abrahamic religions. I reviewed and wrote brief descriptions for these webinars as part of the development of a project website. I was responsible for compiling content for the website as well as providing recommendations for its visual elements and its social media presence. My primary goal during this research position was networking. I wanted to meet professionals in the field of religious studies. I successfully reached this goal through my exposure to scholars who engaged with the project as both facilitators and presenters. My time with this project was quite educational and influential.



One of many texts reviewed when analysing non-binary subjects

“ I witnessed my own growth when it came to professional work and development. I now feel ready with a good amount of skill set to continue within academia post-graduation. I was given the chance to not only improve my academic skills but also appreciate the beauty of the humanities, with its interdisciplinary nature in which my research not only touched on gender studies, but also translation and cultural studies.

“ My experience with the Recognizing Religions project and my interaction with my faculty mentors inspired my desire to apply for a postgraduate program in Religion and Oriental Studies. I have plans to support the PIs with their individual projects moving forward.

GENDER STUDIES

My research project focused on non-binary subjects (*Al-Khuntha*) in Arabic and Islamic intellectual tradition. This is a key-term in judiciary and Islamic scripts, as well as Arabic literature texts. I took part in reviewing various readings and analysis of excerpts from *Jahiliyya* narratives, Arabic poetry, and Islamic jurisprudence *Fiqh* transcripts in this particular area of gender studies. This has given me an insight into the perception of intersexuality and the transsexual identity of pupils within the Arabic and Islamic cultures. The contextualization of a key-term like *al-khuntha* presented us with a closer insight into the lives of non-binary subjects, as well as a further understanding of the consideration of non-binary subjects within social systems in which only traditional binaries conformed with norms and religious assignments. Understanding the historical context of methods of gender assignment and classifications, as well as judiciary rulings of the *khuntha* marriages and inheritances allows us to visualize the modern perspectives of the intersex subject in today's diverse gender system.



Class of 2021

IVY AKINYIMajor
Film and New Media

“ My value for multiculturalism, intersectionality and Pan Africanism manifests in my short films which often present intimate explorations of identity, space and representation from an African female perspective. My experiences learning in elite institutions and in navigating the world as a minority have influenced my cinematic reflections that tend to push the boundaries of spectatorship and technique. My works have been regarded as episodic, poetic and multidimensional.



Snapshot from Ivy's film, Burial



Congratulations to Ivy Akinyi, whose short film News from Home (2020) was showcased at the Alpavirama Online Film Festival in 2020. The film documents Ivy's online interaction with a long-lost friend from Kenya at a time when social distancing is the norm. Additionally, Ivy was awarded a \$500 Summer Film Grant by NYUAD's Film and New Media department, with which she crafted an experimental short film, Burial (2020) that embeds poetry and experimental imagery in its representation of grief. In 2020, Ivy produced six articles for her column, Dear Descendants, on the student-led publication, The Gazelle, to familiarize audiences in the MENA region with Pan African cinema.



Alpavirama film festival



ENGINEERING



Class of 2023

EMMANUEL FASHAE

Major
Mechanical Engineering
Faculty Supervisor
Joo H. Kim

BALANCED REGION ANALYSIS FOR STANDING PUSH RECOVERY WITH ANKLE AND HIP STRATEGIES OF DARWIN-OP3 HUMANOID IN SIMULATION

In the coming years, humanoid robots are expected to become increasingly popular. As they are capable of interacting with, working alongside and aiding humans, research into their development is on the rise. In order to safely coexist with humans, humanoid robots must be capable of navigating dynamic unstructured environments in a safe manner. Currently, the primary challenge plaguing humanoid research is the development of biped robots that are capable of fall prediction and prevention while also maintaining overall stability while walking. Our research investigated the balanced region of a biped robot for standing push recovery in Center of Mass (COM) state space - the set of initial COM positions and velocities at which the robot can maintain balance while standing. Our investigation was conducted using WeBots, an open-source simulation environment, and a simulated DARwin-OP humanoid robot. The maximum velocity at which the robot remains stable under varying initial COM states (COM position and velocity) was obtained to determine an estimated boundary for the balanced region utilizing both ankle and hip strategies. The balanced region determined in this research can then be used with a COM-state-based controller to stabilize the robot or prepare the robot to take a step or brace for a fall if it is unable to maintain balance.



Validation of Balance Stability Regions for Inverted Pendulum Model and DARwin-OP Robot in Simulation

Emmanuel Fashae, Zi-Ming Lee

Applied Dynamics & Optimization Lab

Mentor: Hyunjong Song, Faculty Mentor: Professor Joo H. Kim ADOL, Dept. of Mechanical and Aerospace Engineering, New York University

ABSTRACT

Currently, the primary challenge in developing humanoid robots is developing biped models that are capable of fall prediction and prevention when navigating a dynamic unstructured environment [1]. Our research investigates the balanced region of a biped robot for standing push recovery in Center-of-Mass (COM) state space — the set of initial COM positions and velocities at which the robot can maintain balance. The maximum velocity at which the robot remains stable under varying initial COM states is obtained to estimate a boundary for the balanced region.

BACKGROUND

- Currently, biped systems are very limited in their ability to maintain their overall stability while walking and standing
- To tackle this problem, a valid approach would be to develop biped stability controllers that can steady the COM to maintain balance in the system.
- These controllers will employ joint-level strategies to keep the COM within the balanced boundary region.



Figure 1: DARwin-OP Standing Push Recovery

- For the purpose of this project, the joint-level strategies used in the balance controllers were the ankle strategy and hip strategies.
- The ankle strategy involves rotation of the biped about the ankle joint while ensuring minimal rotation in other joints, allowing the biped mimic an inverted pendulum controlled by torque at its ankle joint [2].
- The hip strategy involves rotation of the upper body of the biped forward and downward, causing the lower body to move backwards while lowering the moment of inertia about the ankle joint [2].

METHODOLOGY

- Webots simulation environment was used with DARwin-OP model, Inverted Pendulum Model (IPM) and Flywheel model.
- Ankle controller was implemented on IPM and robot with a pushing force applied to observe response.
- Similar tests performed with hip controller implemented on flywheel model and robot
- For both ankle and hip strategy simulations, the pushing force was increased until the model fell to obtain the maximum COM velocity for each respective X-position.
 - Initial X-offset was varied in increments of 5 mm.
 - The positive and negative ankle gains were tuned manually to improve push recovery.
 - Hip bias and pelvis bias were also tuned manually to improve push recovery.
- The maximum velocities were tabulated to estimate balanced boundary region.

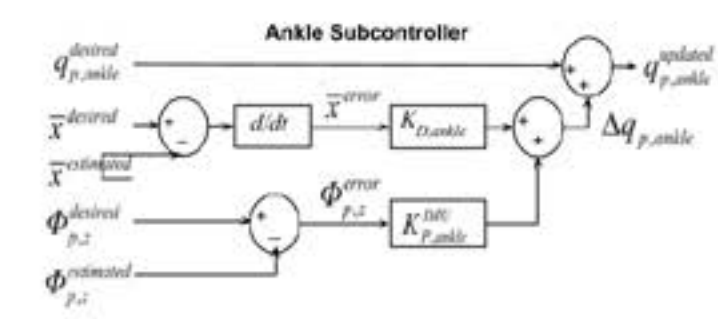

Figure 3: Ankle Subcontroller Block Diagram



Figure 2: Stationary Flywheel Model



Figure 4: IPM with Pushing Force Applied

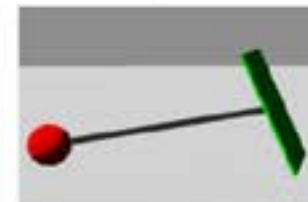

Figure 5: Fallen IPM after Pushing Force Applied

RESULTS AND DISCUSSION

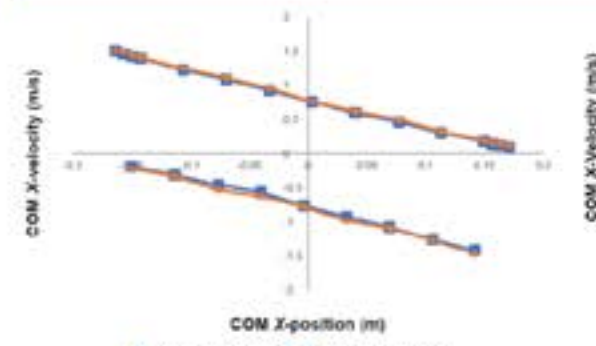

Figure 6: IPM Ankle Strategy

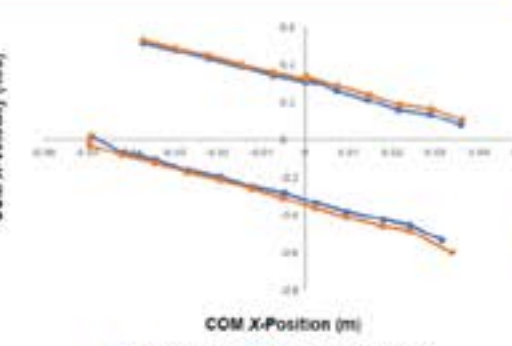

Figure 7: Robot Ankle Strategy

RESULTS AND DISCUSSION (CONT.)

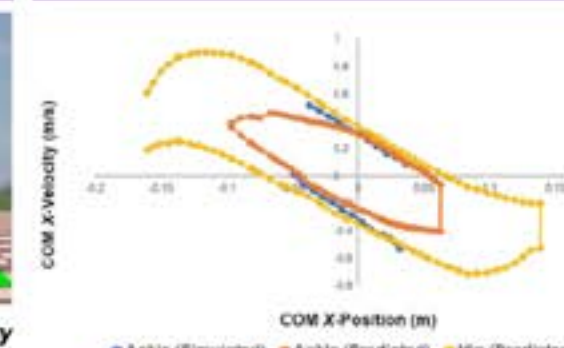

Figure 8: Robot Balanced Boundary

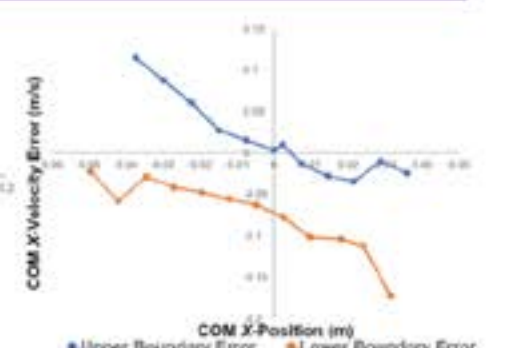

Figure 9: Boundary Errors

- Simulation results show robot's standing push recovery is accurately modeled by IPM.
 - Similar trends in Figures 5 and 6.
- Large Upper Bound Error in range [-0.04, -0.02] and Lower Bound Error in range [0.02, 0.04] likely due to models not being in contact with ground leading to discrepancies in the simulation.
- Ankle strategy data validated for minimal initial COM X-offset
- Hip strategy data shows erroneous discrepancies that require further testing.

FUTURE WORK

- Tune hip controller gains to improve simulation results.
- Further validate simulation results through trajectory mapping with ankle and hip controllers.

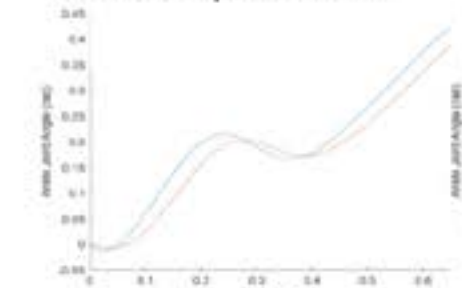

Figure 10: IPM Trajectory Following (Controller Off)

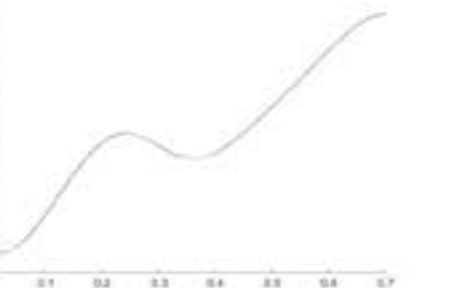

Figure 11: IPM Trajectory Following (Controller On)

REFERENCES & ACKNOWLEDGMENTS

- [1] N. Fukaya et al, "Design of a Humanoid Hand for Human Friendly Robotics Applications"
- [2] G. M. Blenkinsop et al, "Balance control strategies during perturbed and unperturbed balance in standing and handstand"



Class of 2024

PI KO

Major
Computer Engineering
 Faculty Supervisor
Mohamad Eid

DEVELOPING A SOFTWARE TO CONTROL A HAPTIC JACKET

The word “haptics” has its origin in the Greek word *haptikós*, meaning “able to grasp or perceive.” Nowadays, Haptic technology refers to any device which provides a touch experience for users through forces or vibrations.

My summer research role was to develop a software to control a new version of haptic jacket that provides vibrotactile feedback on the upper body, including one-point, multiple-points, and continuous tactile sensation. In short, it is a wireless jacket which lets you feel the touch sensation through the motors embedded in it.

This software, and the haptic jacket, is intended to be used as important experimental apparatuses in the future for psychological experiments. Through this software development experience, I learned how to develop software code in modular approach for easier maintenance, how to use software classes to write cleaner code, how to write software to communicate over UDP protocol, and how to write a cross-platform software.

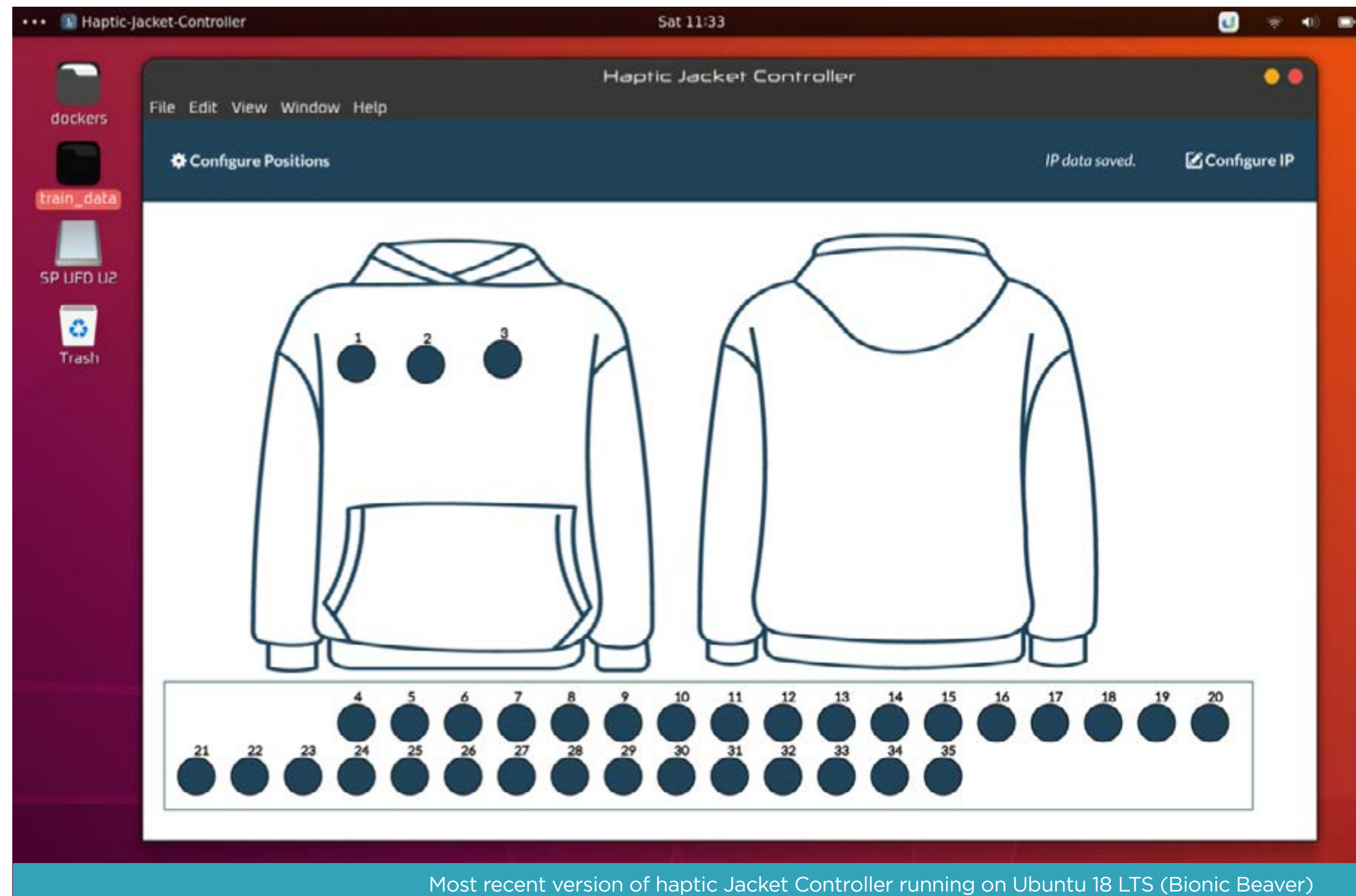

Most recent version of haptic Jacket Controller running on Ubuntu 18 LTS (Bionic Beaver)

Class of 2024



SONYA HSIEH

Major
Computer Science
 Faculty Supervisor
Eduardo Chielle

DEVELOPING FAST DATA-OBLIVIOUS ALGORITHMS FOR HOMOMORPHIC ENCRYPTION

Homomorphic encryption requires data-oblivious programming. This means the control flow and memory access pattern do not depend on the input data. As a result, data-oblivious programming imposes a number of programming restrictions, such as the use of ‘if’ statements negatively affecting performance. In this project, I developed better algorithms for kernel functions such as matrix multiplication that are better suited for homomorphic computation. In addition to devising ingenious algorithms, I explored techniques from SIMD (Single instruction, multiple data) programming and approximate computing to accelerate matrix multiplication.



Class of 2023

SAIDEEP SREEKUMAR

Major
Electrical Engineering
Faculty Supervisor
Mahmoud Rasras

EFFICIENT DESIGN OF OPTICAL CIRCUITS AND AUTOMATION OF LAB EQUIPMENT AND PROCESSES

I took part in a summer research opportunity with the Photonics Research Lab at NYUAD. I looked at how photonics integrated chips can be designed and the different ways they can be simulated, and I looked at various properties and components related to photonics integrated chips. Simplified, photonics integrated chips are optical chips where photons are used rather than electrons to transmit data. Wires in traditional electronics are replaced by waveguides, through which the photons travel. I looked at different types of waveguides—their mathematical equations, and how they physically work.

A large part of my project involved looking into and analyzing the chip design of a device known as a Mach-Zehnder Interferometer made using a photonics integrated chip, and trying to replicate the results of a paper proposing the design of the chip.



Class of 2023

MAYA FAYED

Major
Computer Engineering
Faculty Supervisor
Maurizio Porfiri

HIGH-FIDELITY AGENT-BASED MODELS FOR EPIDEMIC SPREAD

Despite a continued decline in COVID-19 cases across the United States, the enduring effects of the pandemic as well as the possibility of a resurgence in cases due to new variants call for a model that can accurately predict disease spread in cities with varying spatial layouts and demographics. In this effort, we expanded a recently developed Agent-Based Model (ABM) that predicts COVID-19 spread in small to medium-sized US towns based on the lifestyles and complex interactions of their residents.

The original ABM, equipped with the complexity of the disease progression, lockdowns, realistic vaccination, and contact tracing campaigns is now enriched with components related to agents' occupations and mobility and additionally uses the most prevalent Delta variant as the dominant strain. Each employed agent has one of the major professions, all with different risks of COVID-19 transmission. As opposed to the original model, agents can now visit time-off locations that are outside the modeled town, a habit of many relevant populations. We used this enhanced model to study the diffusion dynamics of COVID-19 in three different towns in the state of New York: New Rochelle, Utica, and Colonie. By comparing the spread and the characteristics of infected agents we concluded the impact of each city's structure and demographics on the local COVID-19 toll. Our work provides a general methodology able to ascertain the testing practices, vaccination strategies, and containment policies to counteract the disease spread in urban areas, considering its geographical and demographical features.

Agent-Based Modeling of COVID-19 Spread in New Rochelle, Utica, and Colonie, New York



Summer 2021

Maya Fayed, Silvia Wei
Mentors: Agnieszka Truszkowska, Mohammad Tuqan
PI: Maurizio Porfiri
Center for Urban Science and Progress
Department of Mechanical and Aerospace Engineering
Department of Biomedical Engineering

Background

In a recent publication, our group developed an Agent-Based Model (ABM) to examine the interplay between COVID-19 vaccinations and reopening in the town of New Rochelle, NY. With the original model's parameters scaled to represent the Delta variant as the dominant strain, we now extend this study to cover two more towns in New York state, Colonie and Utica. In doing so, we aim to shed light on the influence of town structure and demographics on COVID-19 spread, and assess how the findings of the original study translate to different locations and variants of COVID-19.

Methods

Database

For the three towns, data on demographics and town structure were collected from the US Census Bureau while information on the buildings (residences, hospitals, schools, leisure locations and workplaces) was collected from ArcGIS, SafeGraph, Google Maps and OpenStreetMap.

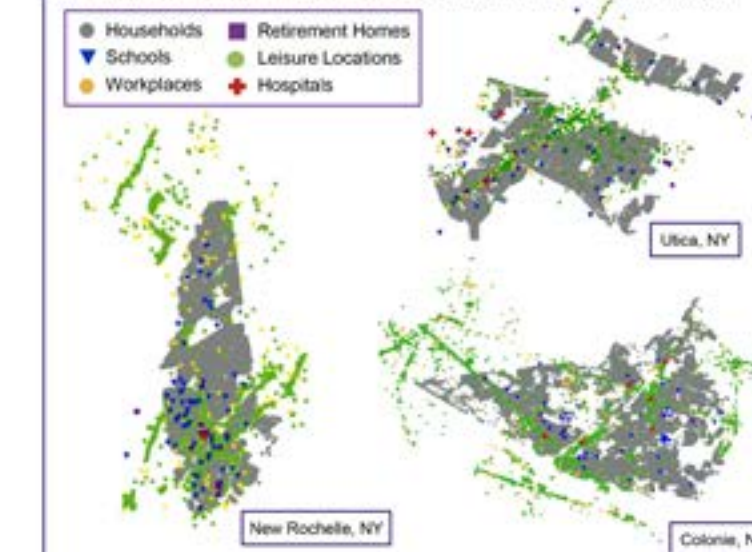

Agent-Based Model (ABM)

ABMs are computational models that simulate the interactions between individuals-agents in dynamic systems and are widely used in epidemiology to study the spread of diseases. Here we use an ABM to predict COVID-19 spread in a community based on the lifestyles and complex interactions of its residents. In this model, agents can work, go to school, visit leisure locations, and visit other agents at their homes. Workplaces and leisure locations can be in-town or in nearby regions. Agents travel to work using cars, carpools, public transportation, and other means of transportation. In our ABM, agents can have different states: **susceptible**, **exposed**, **symptomatic**, **dead**, and **recovered**. Agents can get **vaccinated** (perfect immunity) and can undergo **testing in car** (contactless) or **testing in hospital**. Symptomatic agents can take a state of **normal hospitalization**, **hospitalization in an ICU**, or **be home isolated**.

New Functionality

Agent occupations and out-of-town leisure locations are now modeled in the ABM.

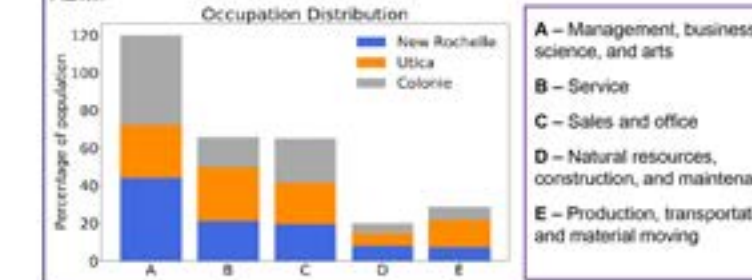

References

- [1] A. Truszkowska et al. High-resolution agent-based modeling of COVID-19 spreading in a small town. *Advanced Theory Simulations*, 4(3):2170005, 2021.
- [2] A. Truszkowska et al. Designing the safe reopening of us towns through high-resolution agent-based modeling. *Advanced Theory and Simulations*, p. 2100157.

Results

We consider three COVID-19 testing scenarios: low efficacy, moderate, and perfect testing. Simulations span three months of Spring 2021.

Predicted COVID-19 toll during for low efficacy testing with actual vaccination rates averaged over all three towns. The bottom and top edges of the box plots mark the 25th and 75th percentiles, the solid lines represent the median, and the whiskers span entire, outlier-free dataset.

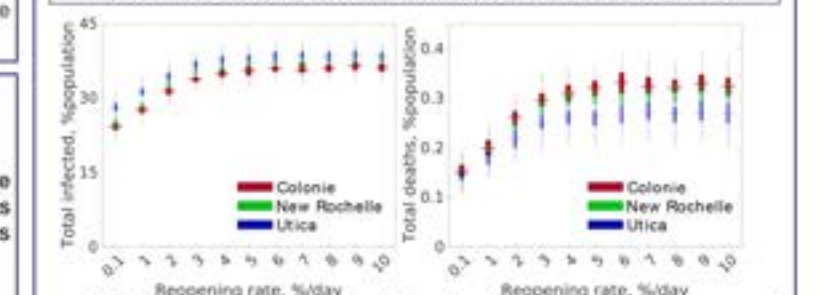

- Infections** – highest in Utica; New Rochelle and Colonie lower and marginally different from each other
- Casualties** - lowest in Utica; higher in Colonie and New Rochelle
- Under real vaccination rates, reopening too suddenly would lead to significant increase in COVID-19 toll: up to 40% more infections, and over twice more deaths.** Highest increase in deaths is observed in Colonie.

Percentage of population infected for different reopening and vaccination rates after three months of Spring 2021

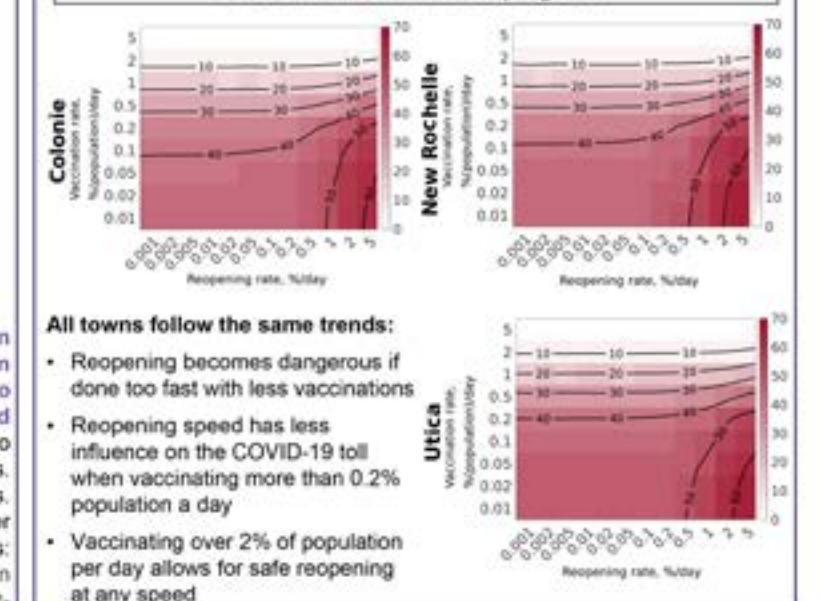

All towns follow the same trends:

- Reopening becomes dangerous if done too fast with less vaccinations
- Reopening speed has less influence on the COVID-19 toll when vaccinating more than 0.2% population a day
- Vaccinating over 2% of population per day allows for safe reopening at any speed

Conclusions

Fast reopening leads to many more COVID-19 cases under fewer vaccinations per day. Above a realistic, vaccination rate threshold, the towns could safely reopen at any speed. The final number of infections varies, with Utica experiencing the most. Our preliminary explanation of this is the dominance of higher-risk occupations in Utica, such as manufacturing, service, and retail. The number of deaths is highest in Colonie and New Rochelle, likely owing to population in those towns being older.

Future Work

- Find explanations for the differences across towns
- Perform in-depth analysis of the type of agents with the highest likelihood for infection in each town

Contact

Maurizio Porfiri
Institute Professor
Center for Urban Science and Progress
Department of Mechanical and Aerospace Engineering
Department of Biomedical Engineering
Room 1327
370 Jay Street
646-997-3681
mporfiri@nyu.edu
http://faculty.poly.edu/~mporfiri





Class of 2022

YUSUF JIMOH

Major
Electrical Engineering
Faculty Supervisor
Mahmoud Rasras

PHYSICAL LAYER DECRYPTION OF SLA 3D PRINTED STRUCTURES USING POLARIZATION ENCODING

Modern-day 3D printing works based on various photonic technologies, from UV curing lamps to lasers and LCD screens. A technology that is quickly gaining market is LCD-based stereolithography. This technology uses an LCD screen to selectively filter UV light that is used to cure a photosensitive resin. This type of printer is becoming very popular and widely adopted, thanks to its low cost. With the prevalence of IoT, however, network-connected LCD-based 3D printers are gradually becoming exposed to network layer security threats. Considering the wide range of applications of 3D printers, from organ and prosthetic printing to weapon printing, the need to effectively secure and protect 3D files from malicious agents is of paramount importance. In this project, we employed a physical-layer decryption technique to secure 3D models. We obfuscated selective portions of a 3D model using AES and then used a series of light polarization steps through sequential LCD screens to decipher the obfuscated portions during printing. By carrying out decryption in the physical layer, we completely thwarted potential network and application-layer threats from external agents including a potentially compromised 3D printer being used to print. We developed a 3D printer add-on hardware and open-source software to orchestrate the process.



Disassembled SLA 3D printer, LCD screen for physical-layer decryption, and laptop showing command-line user interface

Class of 2023



RAMEEN MAHMOOD

Major
Electrical Engineering
 Faculty Supervisor
Muhammad Shafique

DEVELOPING AN OPEN-PLC BASED (SECURE) SMART IOT SYSTEM

Programmable Logic Controllers are widely used in a wide range of industrial/commercial systems, where adaptive and programmable control with real time performance is inevitable. Almost all of the commercial PLC systems are closed source. This project allowed me to get hands-on experience with the Open-PLC research project, and gain an in depth understanding of different key steps including programming in Ladder Logic, compilation of the program to generate an Intermediate Representation (IR), run-time system (RTS), and then executing the program on a Raspberry Pi based PLC hardware. Afterwards, the plan is to explore two key directions: (1) Developing an FPGA-based secure PLC system, where the PLC hardware is realized on an FPGA-based processor that can be

dynamically reconfigured and has hardware-level security primitives to allow only trusted access and execution; (2) Building a Smart Home System using the Raspberry Pi based PLC and Open-PLC project tools.

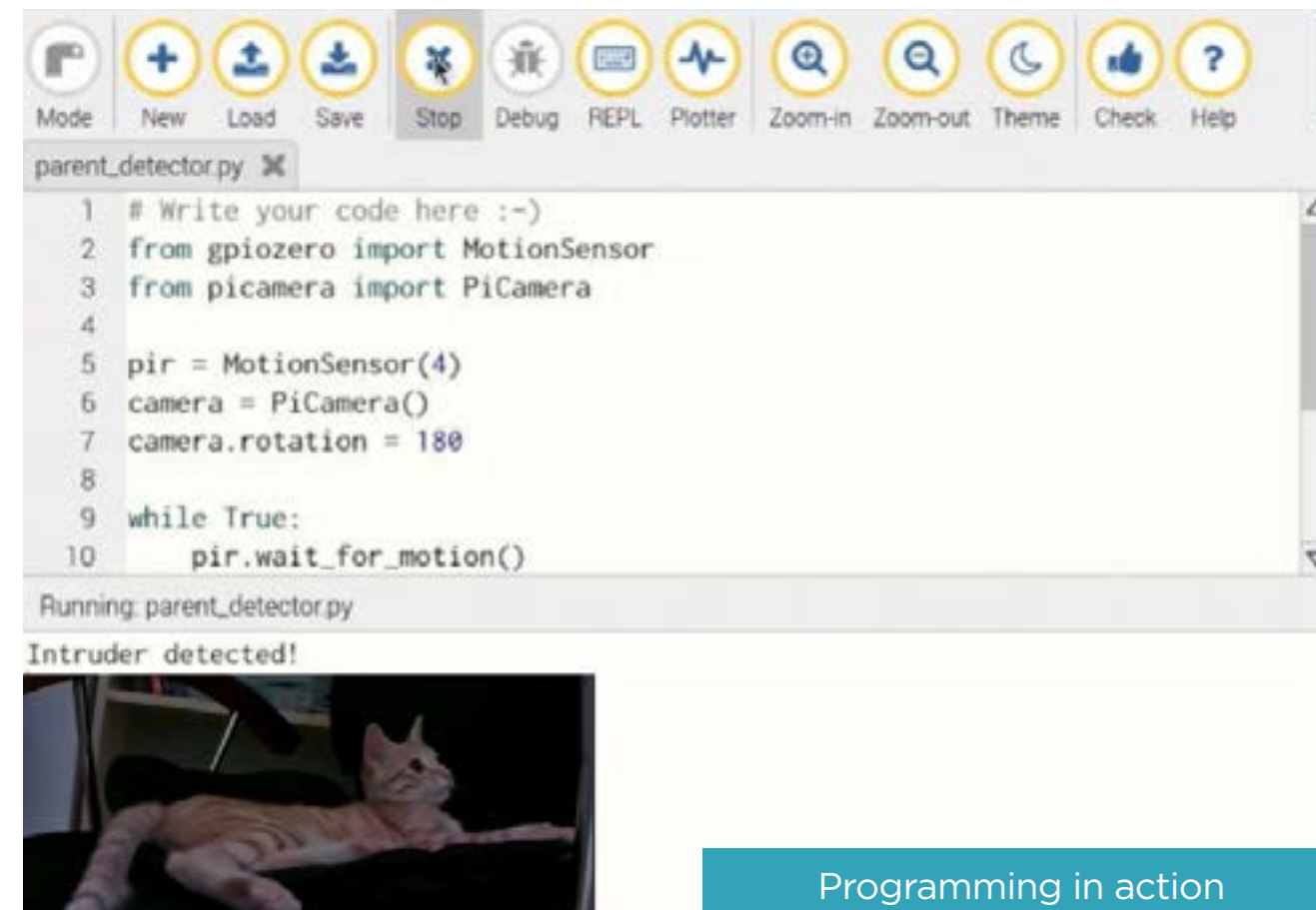

Programming in action

Class of 2021



JULIE XIXUAN LIU

Major
Computer Science
 Faculty Supervisor
Yi Fang



Julie Xixuan Liu, realized that Blind or Visually Impaired (BVI) individuals use haptics much more frequently than the healthy-sighted in their everyday lives to locate objects and acquire object details, which consequently puts them at higher risk of contracting viruses. To augment the BVI's perceptive power, Jullie developed a wearable solution named Artificial Intelligence Crisis Active Risk Reduction System (AI-CARES) so BVI users can perceive objects near and far in their surrounding environment through finger pointing and consequently carry out activities more intuitively, safely, and independently. This project received the award (Engineering category) in the Second Forum for Women in Research. This forum is an opportunity for female researchers to be recognized and supported for their research by the University of Sharjah. Julie started this research project while being an undergraduate research assistant in the NYU Multimedia and Visual Computing (MMVC) Lab under the supervision of Professor Yi Fang.



Virtual touch helps the BVI touchlessly explore their surrounding. For instance, the BVI is notified of the cashier's presence when pointing in the cashier's direction



Class of 2023

MUHAMMAD AREEB ASHAR

Major
Electrical Engineering
Faculty Supervisor
Muhammad Shafique

DEVELOPING EMBEDDED MACHINE LEARNING ALGORITHMS FOR JETSON NANO-BASED ROBOTS

This summer research focused on developing efficient AI and Embedded Machine Learning Algorithms for robotic applications using the Nvidia's Jetson Nano development kit and TensorRT. The goal was to develop accelerating deep learning and inferencing techniques. The work started with me implementing a set of tutorials (already provided by Nvidia) to run Inference using ImageNet and DetectNet to identify objects in the images using pre-trained models such as ResNet-18 and a 91-class SSD-Mobilenet-V2 model that was trained on the MS COCO dataset. After familiarizing myself with this, I created my own framework and object detection programs using Python. The next steps included using transfer learning to train the algorithms on Jetson Nano using a separate set of images and object classes obtained from 'Open Images Dataset V6' using previously trained models mentioned above. After receiving the camera module, I was also able to develop and run live semantic segmentation and object detection using the Jetson Nano, while profiling the performance (in terms of frames-per-second) and resource usage (in terms of memory used) for the inference process. I built the JetBot, a robot that can use transfer learning to avoid collisions, and not only follow objects, but also follow roads. Going forward, I am looking to continue this work with Professor Shafique in order to implement SLAM on the JetBot using the Isaac SDK and autonomous driving algorithms (like lane detection and autonomous parking).

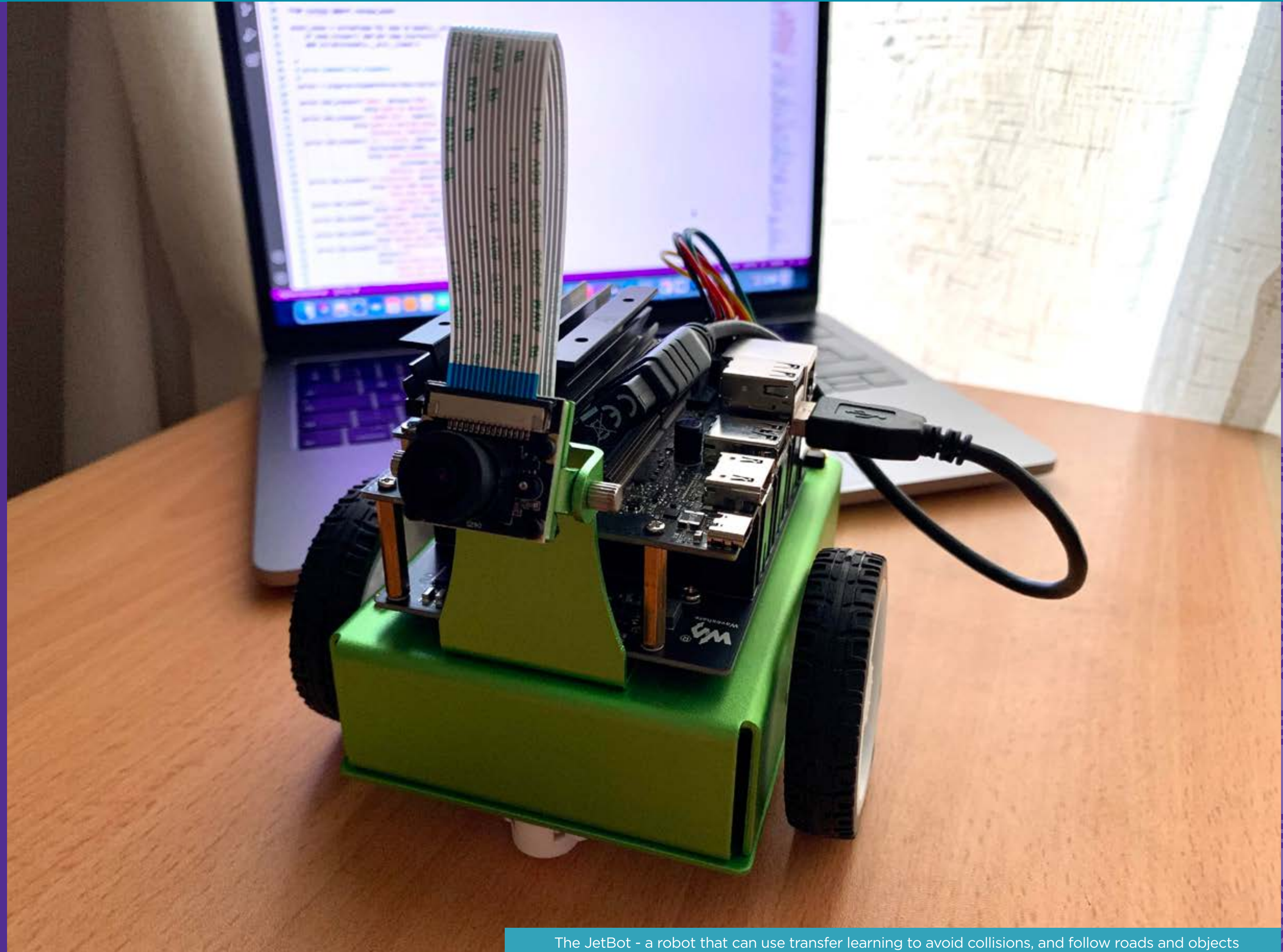

The JetBot - a robot that can use transfer learning to avoid collisions, and follow roads and objects



Class of 2021

QIWEI CHEN

Major
Electrical Engineering
 Faculty Supervisor
Sohmyung Ha



Class of 2021

SANJA KASTRATOVIC

Major
Electrical Engineering
 Faculty Supervisor
Sohmyung Ha

Class of 2023

**SEOYOUNG KIM**

Major
Mechanical Engineering
 Faculty Supervisor
Rafael Song

NON-CONTACT COMPACT PORTABLE ECG MONITORING SYSTEM

Cardiovascular diseases (CVDs) have been listed among the most deadly diseases world-wide. Many CVDs are likely to manifest their symptoms some time prior to the onset of any adverse or catastrophic events, and early detection of cardiac abnormalities is incredibly important. However, traditional electrocardiography (ECG) monitoring systems face challenges with respect to their scalability and affordability as they require direct body contact and cumbersome equipment. As a step forward from the large-scale direct-contact ECG monitoring devices, which are inconvenient for the user in terms of wearability and portability, in this research, we presented a small-sized, non-contact, real-time recording system for mobile long-term monitoring of ECG signals. The device mainly comprises three non-contact electrodes to sense the bio-potential signal, an AD8233 AFE IC to extract the ECG signal, and a CC2650 MCU to read, filter, and transmit them. The device is powered by a 2000 mAh lithium-ion battery with isolation between digital and analog powers on the board using two low-dropout regulators (LDOs). The board's dimension is the size of a credit card, making it optimal to be worn in a shirt chest pocket. In spite of its small form factor, the device still manages to achieve a continuous measurement battery life of over 16 h, total harmonic distortion below -30 dB across the interested frequency range, an input-referred noise as low as 1.46 μV for contacted cases and 5.15 μV for non-contact cases through cotton, and clear ECG recording for both contact and non-contact sensing, all at a cost of around USD 50.

RAPID EXTRACTION OF TARGET RNAs FROM COVID-19 PATIENT SAMPLES USING A MICROFLUIDIC CHIP

Since COVID-19, it has become one of the significant challenges to carry out COVID-19 testing efficiently since it plays a major role in containing the virus. The current sample collection method adopted poses a challenge for the isothermal amplification-based detection as very small amount of solution less than two microliters can be used in a 25 microliters reaction due to the presence of dyes and buffers in the Viral Collection Media that could interfere with the reaction. To establish an isolation process of the RNA from patient samples for point-of-care diagnostics, we adapted a homobifunctional imidoester based microfluidics system to reversibly capture and release a target nucleic acid in a standard buffer solution such as 0.9% saline. The goal of this project was to achieve outstanding performance in rapid RNA extraction with high efficiency and purity from 3 to 4 milliliters of samples. The target flow rate used was 100 microliter/min. Efficiency of 80 percent and 90 percent of purity can be considered as successful result. I was mainly involved in increasing extraction efficiency of synthetic microRNA. Adopted methods to increase the efficiency include refining the design of the channel inside the microfluidic chip using Herringbone structure and manipulating the pH level in RNA extraction step was done to improve the amidine bonding efficiency.



Chen, Q.; Kastratovic, S.; Eid, M.; and Ha, S. "A Non-contact Compact Portable ECG Monitoring System." *Electronics (MDPI)* 10, no. 18 (2021) 2279. DOI: 10.3390/electronics10182279

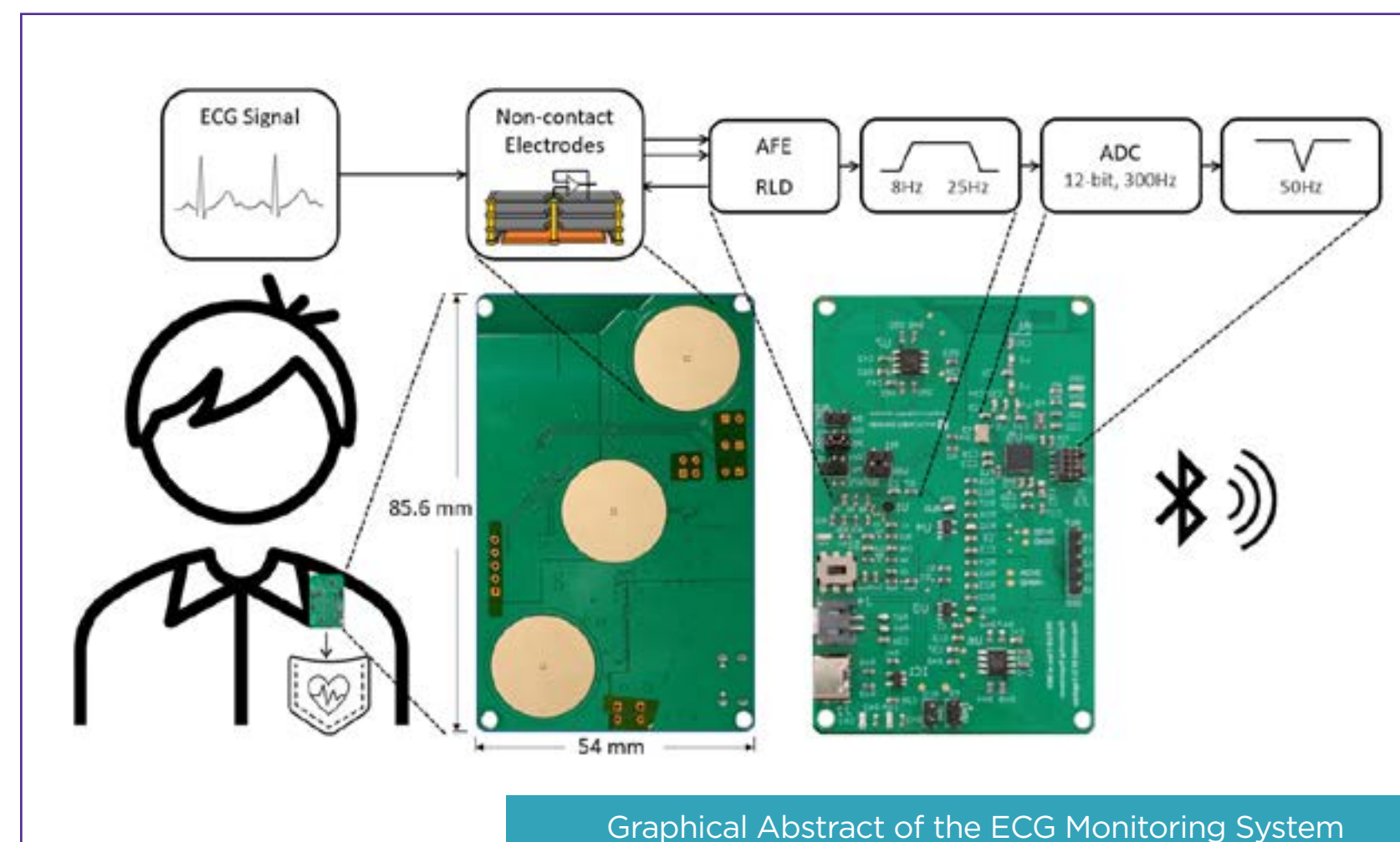

Class of 2023



ABHAY MENON

Major
Bioengineering
Faculty Supervisor
Vijayavenkataraman Sanjairaj

CORNEAL BIOPRINTING

Damage or infection to the cornea can often lead to progressive blindness, for which the preferred course of treatment is a corneal transplant. This poses its own set of problems today due to the lack of donor corneas and eye banks along with post transplant rejection. My research aimed to bioprint a cornea with properties like transparency, curvature and cell viability similar to those of a native human cornea, thereby eliminating the aforementioned problems faced today. To do this, I first created a 3D model of a mold with specifications to match those of an adult human cornea. This was followed by the creation of a digital model of the cornea. I intend to culture human corneal keratocytes and bioprint these cells onto the mold after embedding them in a bio ink that mimics the cells extra cellular matrix as closely as possible.

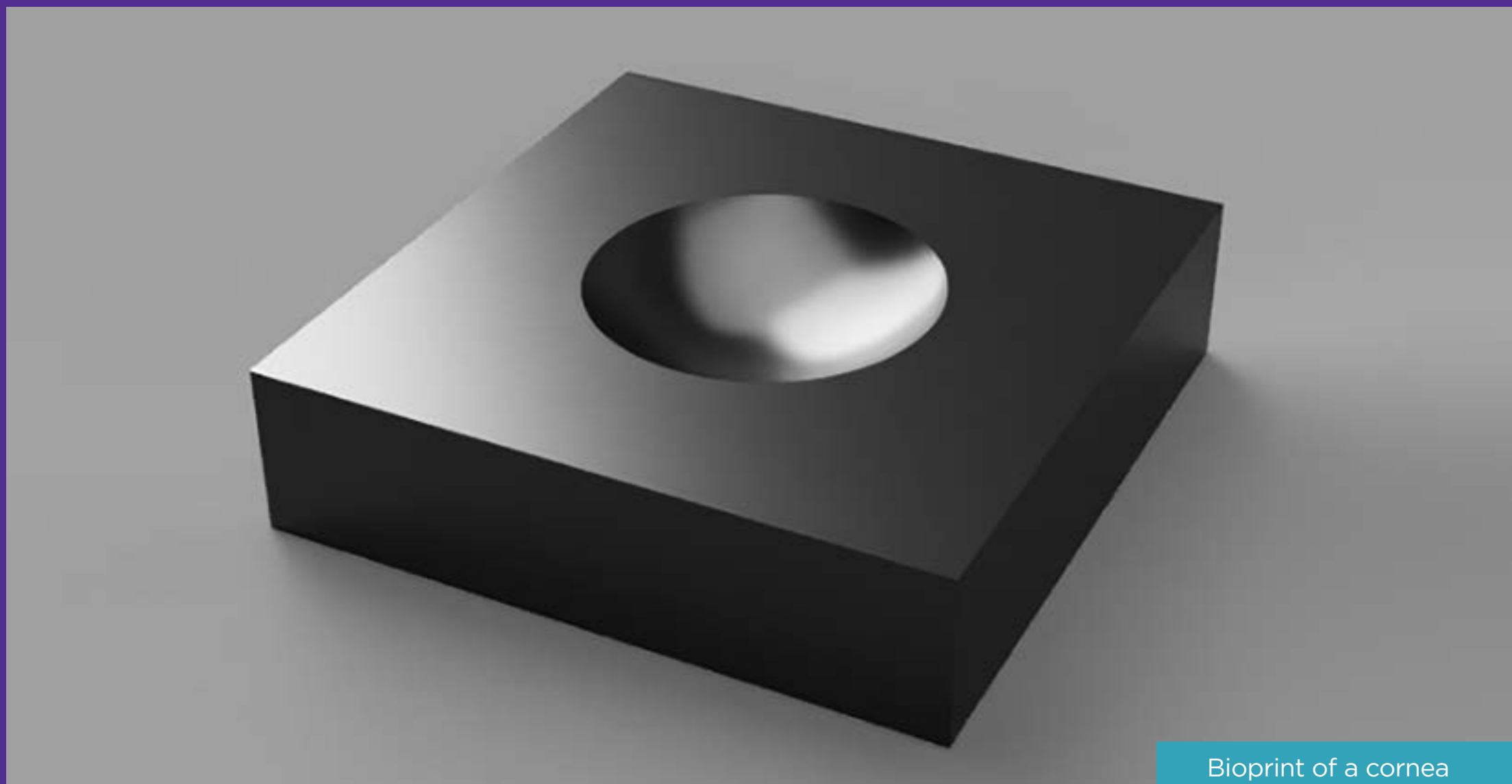

Bioprint of a cornea

Faculty Supervisors Philip Panicker and Daniel Johnson

Class of 2023



FEDERICO JANNELLI

Major
Economics

Class of 2024



NASTASSJA GERLICH

Major
Political Science

Class of 2022



VERA PETROVA

Major
Mechanical Engineering

The following students also provided invaluable support as part of Team NYUAD Green Arabia:

- YEHOWAHI SEKAN**
- STEFFANIE DIAS**
- ELVIRA SELIVANOVA**
- KEVIN KURIAKOSE JOSEPH**
- YAMAN GARG**
- HANNAH KASAK-GLIBOFF**

SWISS MIDDLE EASTERN CIRCULAR ECONOMY YOUTH INITIATIVE (SMECEYI) PROJECT

Beginning in AY 21-20, and continuing into the next AY, Team NYUAD Green Arabia is developing a combined and innovative solution that leverages microwave-induced plasma gasification (MIPG) and membrane bioreactors (MBRs) technologies to build a sustainable future by greening the deserts and growing the agricultural sector in the UAE. One of our primary objectives is to introduce a waste management technique that would help the country achieve negative carbon emissions and reach its goal of topping the Global Food Security Index by 2051.

The Swiss-Middle East Circular Economy for Youth Initiative (SMECEYI) is a competition for university teams seeking sustainable solutions for wastes along with youth empowerment and is sponsored by the Swiss Pavilion at the Expo 2020 Dubai.



Class of 2024

MAHMOUD ELBEH

Major
Chemistry and Biology

Faculty Supervisor
Khalil Ramadi

DEVELOPING BIOACTIVATABLE NANOMATERIALS FOR THE EARLY DETECTION OF ALZHEIMER'S DISEASE; RECYCLING PLASTIC BAGS INTO USEFUL CARBON NANOMATERIALS FOR BIOIMAGING APPLICATIONS

My research work involved designing bioactivatable materials that will enable the early diagnosis of Alzheimer's disease via identifying the causing bacteria in the brain. We utilized nanotechnology to design materials that possess unique optical properties thanks to their ultra-small diameters. These materials known as Quantum Dots have been a very active area of research due to their unique optical properties that are altered by the change in their size and concentration. Parallel to this project, we also worked on synthesizing Quantum Dots from plastic and surgical masks' waste and then measuring their cell toxicity to be able to determine their biocompatibility and the possibility of using the masks for in vivo and vitro imaging.



Mahmoud next to the spectrophluorometer which is used to measure the fluorescence and excitation of the materials developed in the lab



Mahmoud adjusting the concentration of synthesized silicon nanomaterials before collecting its optical properties

Class of 2023



JESPER HOLTER

Major
Bioengineering

Faculty Supervisor
Khalil Ramadi

APPLYING BISTABLE AUXETICS TO INTESTINAL STENTS

The nervous system can be thought of as a large interconnected circuit which spans the whole of our bodies. Instead of wires, it is made up of a network of cells called neurons. In addition to allowing the brain to communicate with different parts of the body, the nervous system allows us to communicate with the brain by stimulating different organs. This can have various therapeutic implications. By stimulating the gastrointestinal (GI) tract with electrical or chemical impulses, diseases such as diabetes and obesity could be treated. My research revolved around developing devices called stents, which can anchor themselves in the GI tract and allow us to release electrical or chemical signals. More specifically, I investigated how bistable auxetic patterns could be applied to improve the properties of the stents. Bistability would allow the stents to be contracted after use and easily removed while auxeticity would make the devices less likely to accidentally dislodge.



Class of 2023

XINYUE LI

Major
Mathematics

Faculty Supervisor
Bin Fang

INVESTIGATING THE POTENTIAL OF COMBINING AR-BCI (BRAIN-COMPUTER INTERFACE) AND COMPUTE VISION TO CONTROL ROBOTIC ARMS

My summer research position was based at the Artificial Intelligence and Robots Research Lab, at Tsinghua University, in China. My work focused on investigating the potential of combining AR-BCI (brain-computer interface) and compute vision to control robotic arms, which is expected to further promote the practicality of BCI-controlled robots. Paralysis and other injuries which cause neurologic disorders severely hinder an individual's daily performance of reaching and grasping movements in daily activities. Since already existing techniques are challenging for severely motor-impaired individuals, it is necessary to develop more advanced technology, such as BCI. BCI aims to build a new control channel between human and external devices by decoding human brain signals and can be used to improve basic activities of daily living for severely motor-impaired individuals.

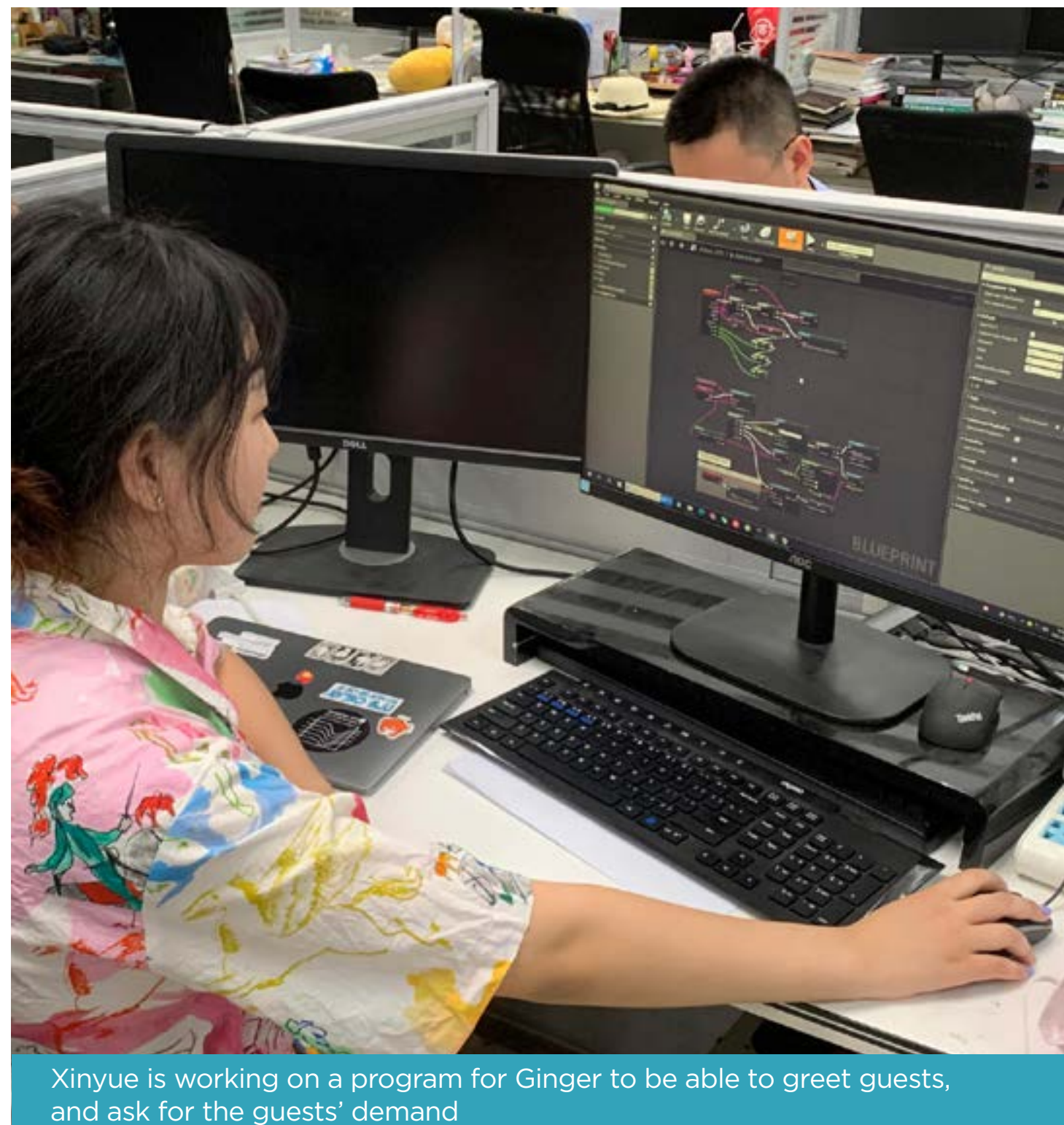

Xinyue is working on a program for Ginger to be able to greet guests, and ask for the guests' demand

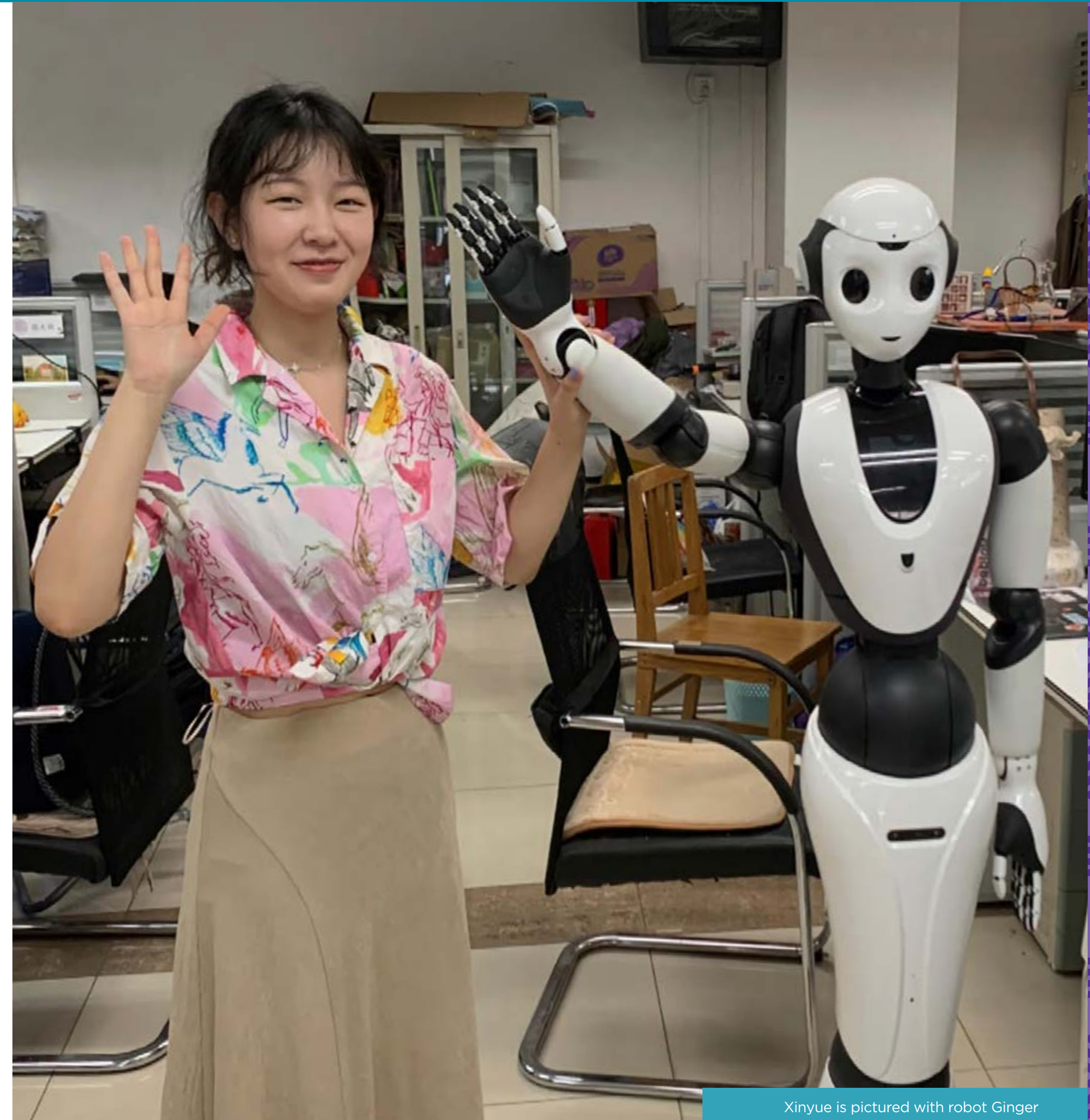

Xinyue is pictured with robot Ginger



SCIENCE

Class of 2023



HUNWOO YANG

Major
Chemistry

Faculty Supervisor
Panče Naumov

INTRODUCTION TO ANALYSIS AND CHARACTERIZATION OF SMART MOLECULAR MATERIALS THROUGH CRYSTALLOGRAPHY

Smart dynamic materials, also known as responsive materials, are capable of changing their properties by external stimuli such as stress, moisture, electric or magnetic field, temperature, and more. Specifically, the lab focused on the performance of soft actuators that could convert energy from light or heat to mechanical work, which can further be transferred as electricity or motion. The objective of the research was to prepare, analyze, and assess the performance of the new smart molecular materials by being introduced to material characterization. During the summer experience, I was able to acquire knowledge and information of the theory behind crystallization, characteristics of different crystal structures, and techniques that were used to investigate the properties of crystals, namely x-ray crystallography. X-ray diffraction is used for direct observation of crystal and molecular structures at an atomic scale, and even allows observation and identification of structure of intermediates from the reactions when they exist in extremely small amounts for a short period of time. Over the summer, I have also learned about basic properties of different materials and the application of various methods that are available for their characterization.

Class of 2023



RYOJI KUBO

Major
Computer Science

Faculty Supervisor
Djellel Difallah

LEVERAGING HYPERBOLIC EMBEDDING IN QUESTION ANSWERING OVER KNOWLEDGE GRAPH TASK

Knowledge Graphs (KG) captures entities, types, and relationships that are relevant to specific domains. Question Answering over KG (KGQA) task is to answer Natural Language queries posed over the KG. To accomplish this task, graph embedding methods have been utilized. Recently, there has been a surge in research on using hyperbolic geometry to learn graph embeddings due to its suitability for preserving hierarchical relations. This research project leveraged hyperbolic embedding to KGQA tasks and compared its performance to other existing embedding methods. We conducted our comparison by extensive experiments on multiple benchmark datasets. Specifically, I was responsible for the inference tasks, analyzing the performance of the KGQA task with regards to how hierarchical the Question is in nature. I have shown that for Multi-hop Questions, questions that are more hierarchical tend to yield higher accuracy using hyperbolic embedding. During our research, we discovered that the current metric of curvature of the embedded hyperbolic space highly fluctuates due to its locality and does not take into account the dimension of the embedding space. We plan to work on different metrics of curvature and empirically evaluating them for us to be able to accurately choose which hyperbolic space to embed our graphs into.

Class of 2023



MATTHEW VARONA

Major
Computer Science and Interactive Media

Faculty Supervisor
Enrico Bertini

A PERTURBATION-BASED APPROACH TO CALCULATION AND VISUALIZATION OF MULTIDIMENSIONAL CLASSIFIER DECISION BOUNDARIES

In high-stakes applications of machine learning such as healthcare, understanding a model's decision space can help users debug the model during production and calibrate their trust in the model when making key decisions. Previous approaches to visualizing machine learning model boundaries have used 2D projections of multidimensional data, which confirm the existence of a boundary but provide little information about how different features affect model output. We proposed a gradient descent-based method that perturbs model input to compute exact points along multidimensional decision boundaries of classifier models. We then developed an interactive visualization of the space around these boundary points that emphasizes feature relationships. By algorithmically selecting and ranking feature groups, we provided data practitioners with a guided way to explore model behavior in areas close to decision boundary points.



Class of 2023

VICTORIA MARCANO

Major
Psychology and Art History

Faculty Supervisor
Olivia Cheung

DEVELOPING A LOCALLY-RELEVANT LOCALIZER TO IDENTIFY FACE- AND PLACE-SELECTIVE REGIONS IN THE HUMAN BRAIN

High-level cognitive functions, such as recognizing faces and navigating through environments, are important skills in our everyday life. In this project, we aim to build a stimulus set for a simple naming task that would be optimal to identify brain regions that are active when processing faces and places using fMRI. For this purpose, we have surveyed members of the target populations to study (NYUAD students and the adult local population of the UAE) and collected a set of images of famous faces and places according to the cultural background of these populations. The images constitute the stimuli for the experiment, which participants will be shown while their brain activity is measured in the fMRI.



Class of 2023

WILDER WORRALL

Major
Biology

Faculty Supervisors
Justin Wilcox and Stephane Boissinot

SKIN MICROBIOME, SPECIATION, AND ALTITUDE ADAPTATION IN ETHIOPIAN FROGS

My summer research project aimed to assess the relative roles of speciation and habitat on the skin microbiome of frogs in Ethiopia with a particular focus on microbial changes relating to changes in altitude. In this project, I was able to develop the lab work and research-specific literature skills I would have otherwise lacked due to the COVID-19 related restrictions put in place. Over the summer period, I completed a large portion of the work needed to prepare the field samples for sequencing. I performed DNA extractions specific to skin swabs, DNA quantification with Qubit, and PCR amplification of these extractions. During this time I also wrote and standardized my own protocols based on kit-provided procedures and literature reviews. Furthermore, I enhanced my understanding of the dynamics within a research lab and the culture of academia.

Class of 2023



REEM HAZIM

Major
Computer Science

Faculty Supervisors
Nizar Habash and Muhamed Al-Khalil

ARABIC READABILITY ANALYSIS TOOLS

For my summer research project, I worked on developing tools that analyze the readability level of Arabic text. For example, I maintained and improved a Google Docs add-on aimed at supporting the simplification of Arabic novels for young readers. This tool assesses the readability of Arabic text in a Google Doc and offers suggestions to simplify the text. I developed several new features that enhance the flexibility and quality of the tool, including a feature that displays related words (synonyms, antonyms and hypernyms) and their readability levels for each lemma (dictionary entry). This feature facilitates the process of Arabic text simplification by helping the user find related words that may be more suitable for readers at lower reading levels.

In addition to maintaining this Google Docs add-on, I developed a Google Chrome extension that displays the readability level of any Arabic text selected from a webpage. I also built an Application Programming Interface (API) in Python that can assess readability programmatically, which could facilitate the analysis of large datasets of Arabic text. By implementing this diverse set of readability analysis tools, we enable users and researchers to easily leverage the latest resources for Arabic readability in different contexts.



Class of 2022

MARK PENJUELI

Major
BiologyFaculty Supervisor
Aashish Jha

DISENTANGLING THE GENETIC STRUCTURE AND POPULATION HISTORY OF NATIVE HAWAIIANS

The Pacific region is known to be the last frontier of ancient human migration. This has long intrigued historians, anthropologists, and scientists, and with the advent of novel computational techniques that decipher information held within human DNA, we can now provide scientific evidence to either reinforce or challenge current archeological records. In the summer, I began work in collaboration with researchers at Stanford University to disentangle the genetic structure of modern-day Hawaiians using publicly available genotype data as well as newly generated single nucleotide polymorphism (SNP) array data from global populations. The main research questions to address were: given the recent findings of prehistoric Native American gene-flow into east Polynesian islands that predated European settlement, is it possible to infer whether similar introgression occurred with the Hawaiian Islands? And if so, can we construct models of human migration across Polynesia prior to the arrival of Europeans using local ancestry inference? This research also incites further selection-based studies on medically relevant genetic variants that might have undergone selection in these isolated island environments. In AY 21-22, I will apply this knowledge to investigate the population structure of the Gulf as well as the Himalayan region.

“In the Pacific, most if not all cultural knowledge and historical records are passed down through oral stories. Being a native of Polynesian descent, this, coupled with the fairly understudied nature of the Pacific region, brings me a great sense of engagement to carry out research on this region of the world.”

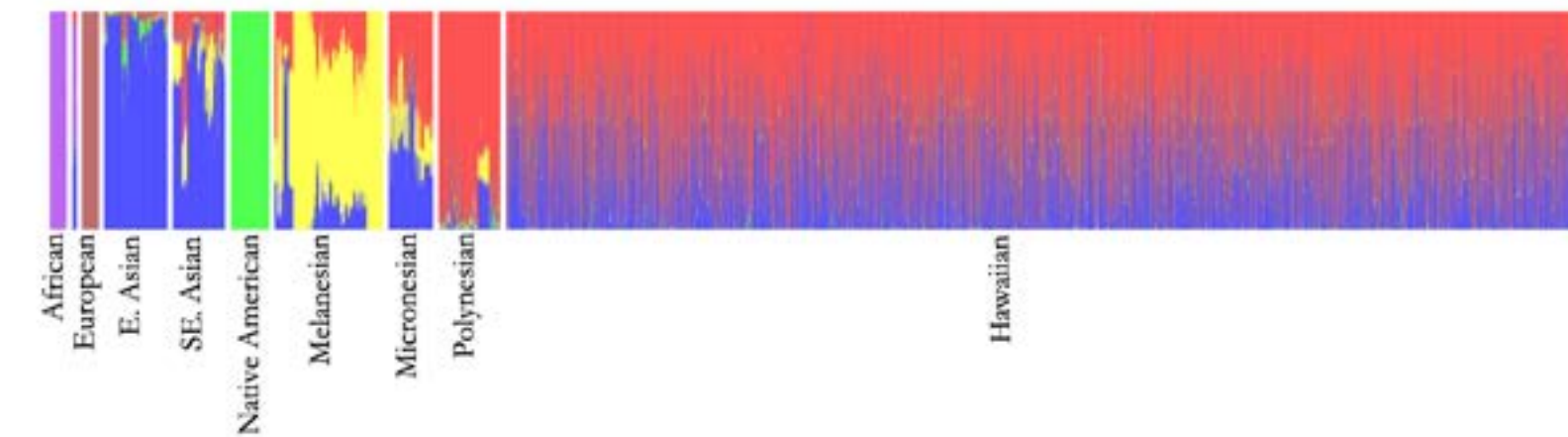

K = 6 clustering analysis of Hawaiians and reference populations using ADMIXTURE

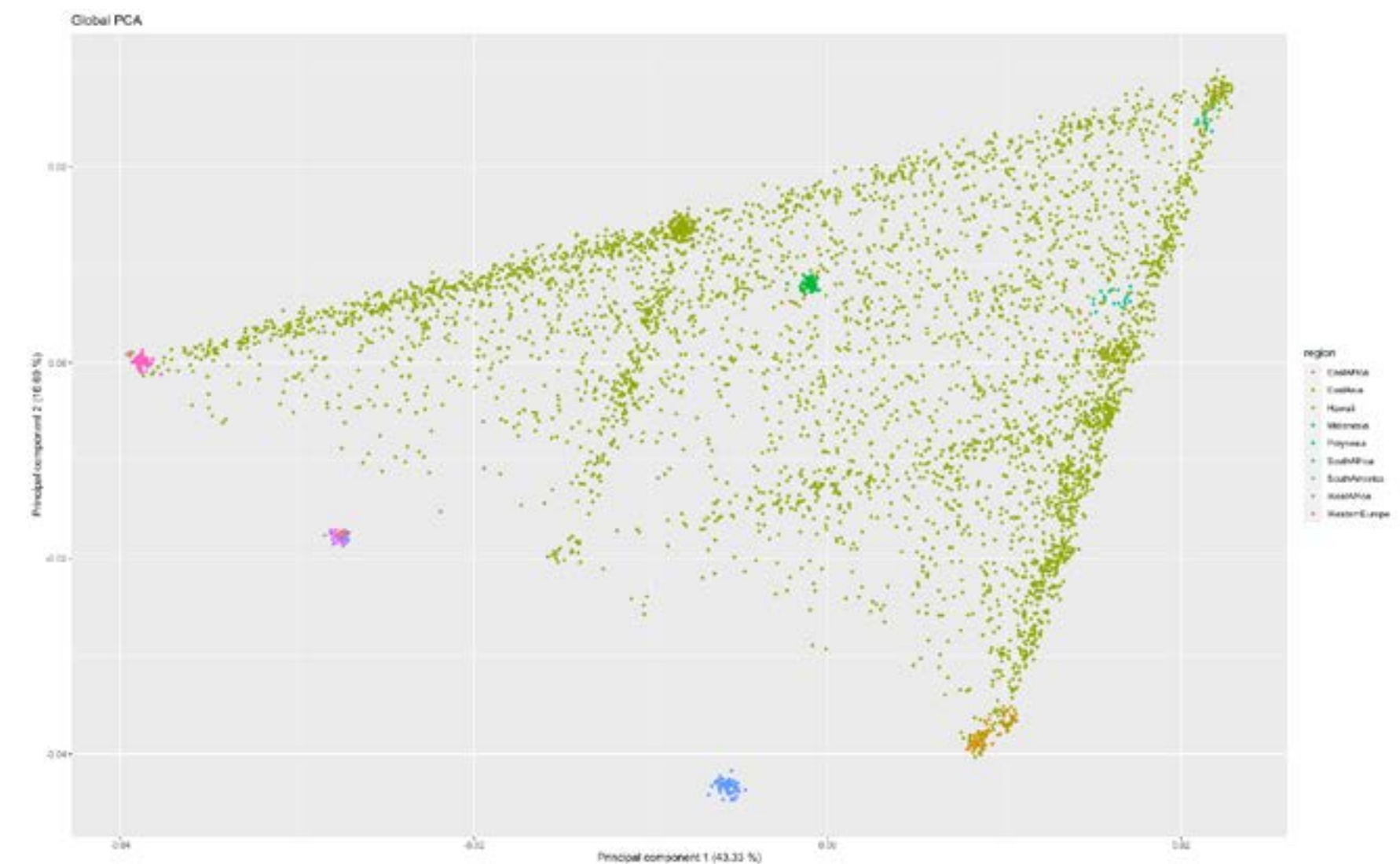

Principal components analysis of continental ancestries in Polynesian individuals



Class of 2022

IAN THOMAS MCBAIN

Major
Biology

Faculty Supervisor
Kirsten Sadler Edepli

IDENTIFYING WHETHER THE INNATE IMMUNE SYSTEM PROMOTES OR IMPEDEDS HEPATOCELLULAR CARCINOMA

My research involved investigating whether the immune system promotes hepatocellular carcinoma (a deadly and predominant form of liver cancer worldwide) in a zebrafish model. The team worked with a zebrafish model where they overexpress human UHRF1 in the zebrafish hepatocytes and by day 14, it is possible to see instances of hepatocellular carcinoma. Zebrafish are a great model to work with because they are transparent as they develop so it is possible to visualize their livers and immune cells at critical time points. My summer research involved identifying whether canonical genes that recruit immune cells and create inflammation are overexpressed in these livers.

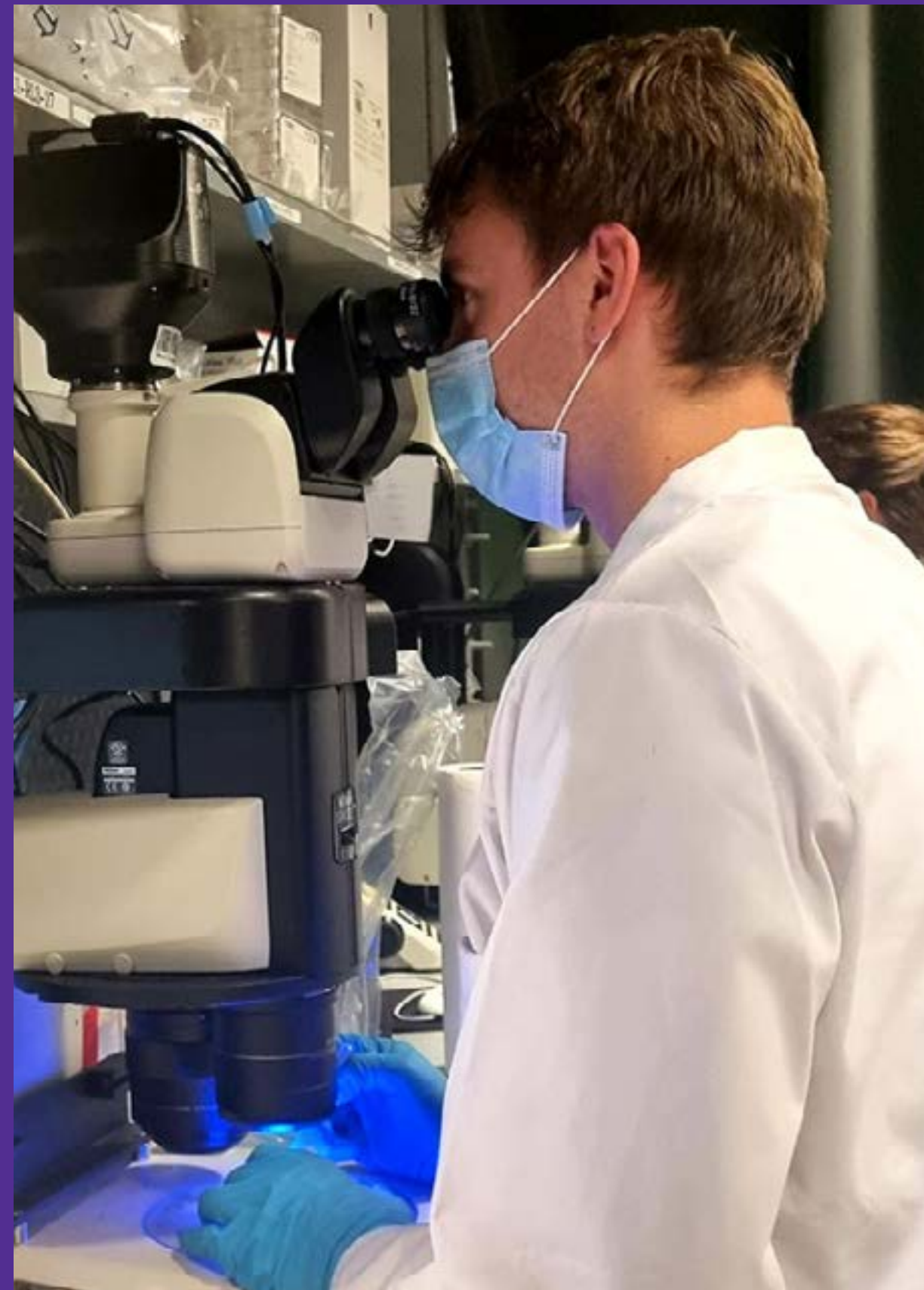

Ian is screening fish for the presence of a transgene that is tagged with a fluorescent GFP protein. Fish that have this protein can be seen to have green livers and can then be used to test whether the immune system promotes liver cancer in fish that overexpress hUHRF1

Class of 2024



AKSHAT TOTLA

Major
Computer Science

Faculty Supervisors
Hanan Salam and Himadri Mukherjee

AI FOR DEPRESSION DIAGNOSIS

I developed an intuitive software interface using the PyQt5 module in Python where users can record or import their audio and the algorithm would detect depressive tones in real-time through an effective speech-based depression recognition deep learning model. This software project would work well to test and validate the idea of machines better understanding emotions and furthermore building a virtual AI-based mental health counselor.

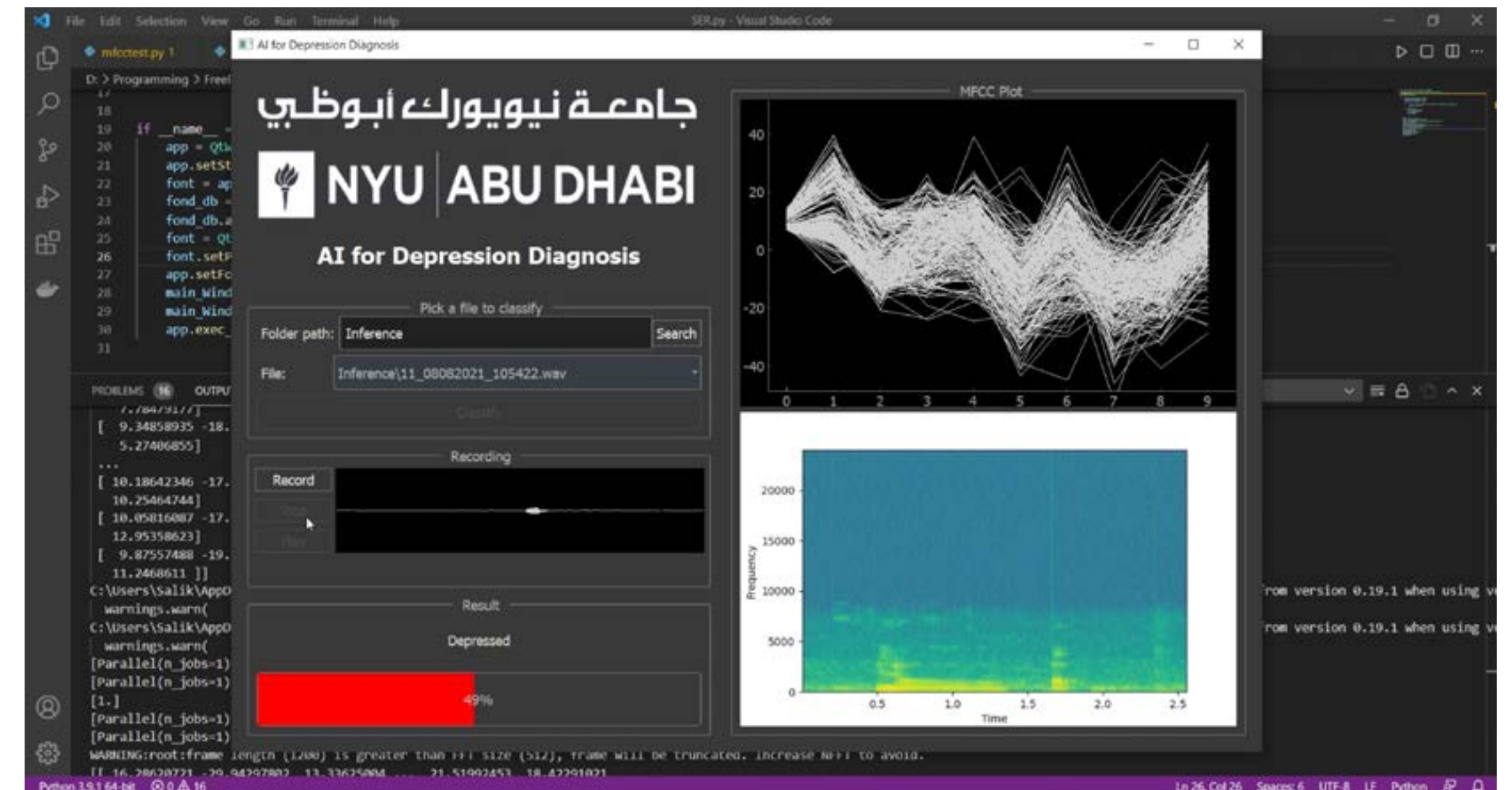

Screenshot of the software interface developed in Python for using the machine learning model to detect depressive tones from the user's voice sample

Class of 2023



ABIGAIL AMA KOOMSON

Major
Biology and Creative Writing

Faculty Supervisor
Kirsten Sadler Edepli

EFFECTS OF INORGANIC ARSENIC EXPOSURE

My work over the summer investigated the sustained effects of inorganic Arsenic exposure using zebrafish as a model organism. Arsenic is one of the harmful metalloids present naturally in the earth's crust and prolonged exposure to it has adverse health outcomes on organisms who are exposed through water and food. My research project contributes to knowledge on the functional relationship between cell stress responses - namely the Unfolded Protein Response - that is activated when cells are exposed to inorganic arsenic.

“It is wonderful being able to watch zebrafish embryos develop from the single cell stage to the adult stage right before my eyes under a microscope! I am grateful for the highly motivated and talented community of scientists and undergraduate students that I get to work with, and for the amazing resources and facilities available to researchers at NYUAD.



Abigail extracting RNA from a pool of dissected zebrafish livers



Abigail in the zebrafish facility (fishroom), putting a tank of zebrafishes on 'system'

Class of 2024



STUTI SUSAN JERALD JAMES

Major
Psychology

Faculty Supervisor
Antje Von Suchodoletz

BEHAVIORAL OBSERVATION OF CAREGIVER-CHILD INTERACTIONS USING EYE TRACKING DEVICES

I worked in the Teaching, Learning and Development Lab as a part of the 'Eyes at Home' project. This was a large-scale project that used eye tracking devices to study interactions between mothers and their children during play time activities such as reading and cleaning. Given that the study was conducted across several countries and observations were originally recorded in many different languages, my facility with the Tamil language allowed me to code data that was collected from South India specifically. As a research assistant, my work involved running through recorded video observations, splitting them into short 2-second time frames and assigning values for each interval based on behaviors (i.e., Initiating, Quizzing, Teaching, Responsivity, Praising, Correction, etc) observed in a single frame.

“Working as a research assistant was an invaluable experience that allowed me to hone my communication, observation and time management skills. It was a great opportunity to get hands-on experience and explore a topic which I would not have had the chance to otherwise.

Cranleigh High School

Faculty Supervisor Justin Wilcox



RILEY FEWER

BIOINFORMATICS AND FALCON GENOMICS

In collaboration with the NYUAD Office of Undergraduate Research, the Center for Genomics and Systems Biology mentored four year-12 students at the Cranleigh International British School in Abu Dhabi. Students received training in the basics of the Bash computing language, including but not limited to: directory and file creation and navigation; script writing and submission; GNU tools for data processing; and, use of regular expressions. Using these skills and the NYUAD Dalma High-Performance Computing Cluster, the research interns then conducted a guided analysis that reconstructed the evolutionary relationship between members of the falcon family (Falconidae) using contemporary techniques in: big data, sequence alignment, and phylogenetic tree construction. The analysis, which focused on 190 archival sequences of the Falconidae Cytochrome Oxidase B Gene, revealed incomplete lineage sorting of this gene within the large falcons that dominate falconry in the UAE, and affirmed the need for full genome-wide analyses for differentiation of large falcon species.

Cranleigh High School



AMAAN SHEIKH

Cranleigh High School



RAYYAN GHOOR

Cranleigh High School



XINQIAN 'CARMEN' LI

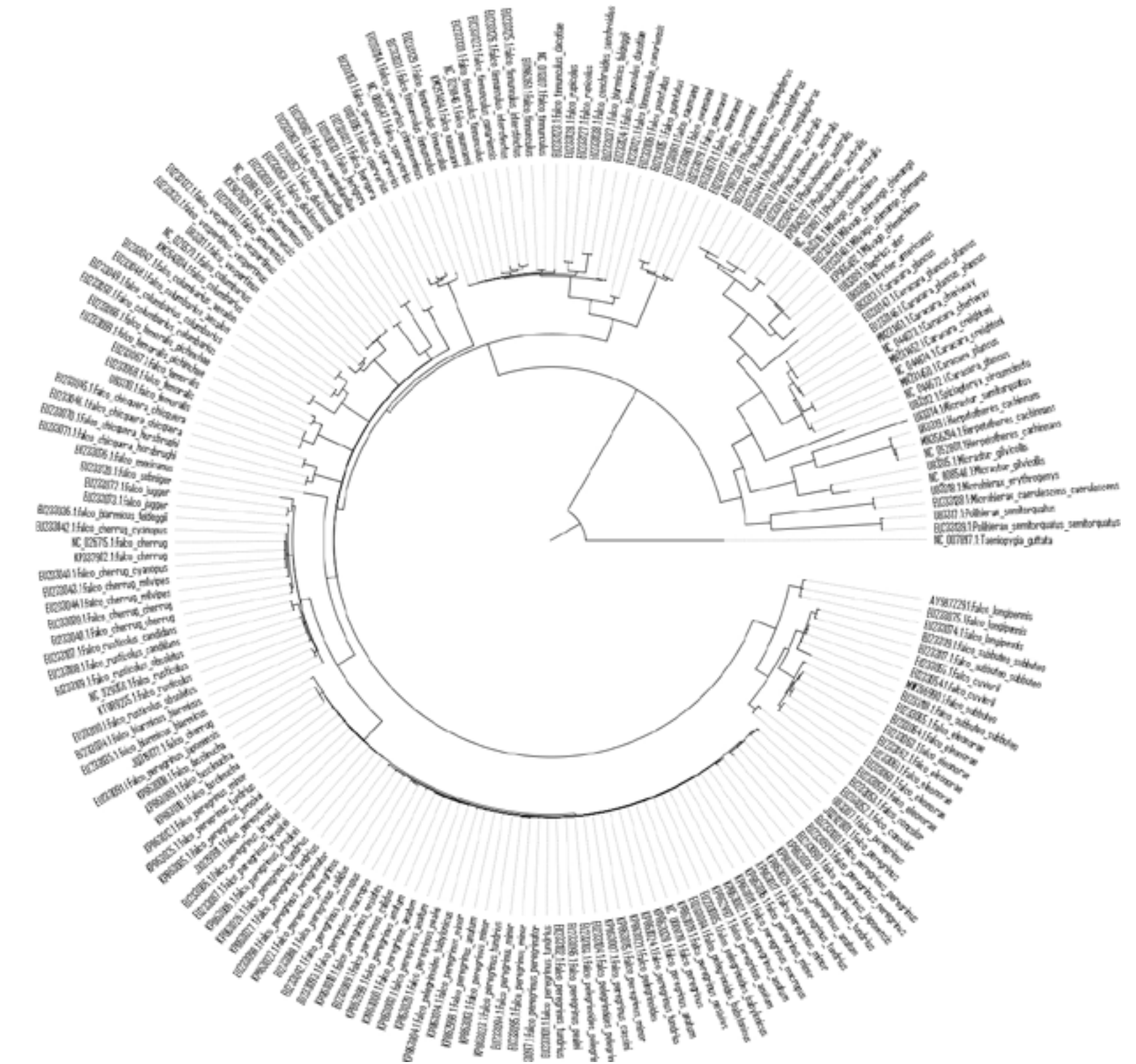

190 sample Bayesian tree of all archival copies of Cytochrome Oxidase B for members of the falcon family available of NCBI Genbank. The tree construction and all data processing was performed by Xinqian 'Carmen' Li

“ I am very grateful to Dr. Wilcox for providing this incredible learning opportunity. This experience provided me with an insight into how university research is conducted. I was also able to acquire new skills such as keeping records of code scripts, and ultimately, constructing a phylogenetic tree by using a wide variety of falcon genome.

XINQIAN 'CARMEN' LI

Faculty Supervisor David Holland

CENTER FOR SEA LEVEL CHANGE

The Center for Sea Level Change at New York University Abu Dhabi combines observations and computer models to understand past, and project future, sea-level rise. The center, led by David Holland, brings together regional and international research experts to tackle this challenging and societally relevant problem.



NYU ABU DHABI
Class of 2023

**SASHANK
SILWAL**

Major
Computer Science



UAE UNIVERSITY
Class of 2024

**FARAH
AYYAD**

Major
Information Security



NYU ABU DHABI
Class of 2023

**NGOC
HOANG**

Major
Computer Science

IMPLEMENTATION OF A GRAPHICAL USER INTERFACE TO VISUALIZE THE IMPACTS OF SEA-LEVEL RISE FOR COASTAL PLANNING

Sea-level rise (SLR) poses a range of threats to natural and built environments. Understanding the SLR-induced hazards in a region is essential for informed decision making. We aim to develop a probabilistic approach using a combination of Bayesian Network (BN) and visualization through a user-friendly platform. The approach calculates the probability of a long-term shoreline change given physical parameters, relative sea-level rise, and land use to evaluate the SLR influence in a specific region. As part of a two-month internship, we developed a probabilistic model that assesses the likelihood an area will inundate (flood) or dynamically respond (adapt) to SLR. The project was developed using open-source code (Python) and uses the Abu Dhabi coast as a study case. BN is ideal to combine historical, current, and projections of phenomena by integrating observations to evaluate relationships between forcing factors and coastal responses. The assessment of that information can be expressed by numbers or percentages or by established likelihood terms. The platform consists of a user-friendly interface, a data-driven model using BN, and an interactive coastal response that considers different parameters in a region to determine both inundation and dynamic response by providing statistical analysis and a range of adaptation scenarios for SLR.

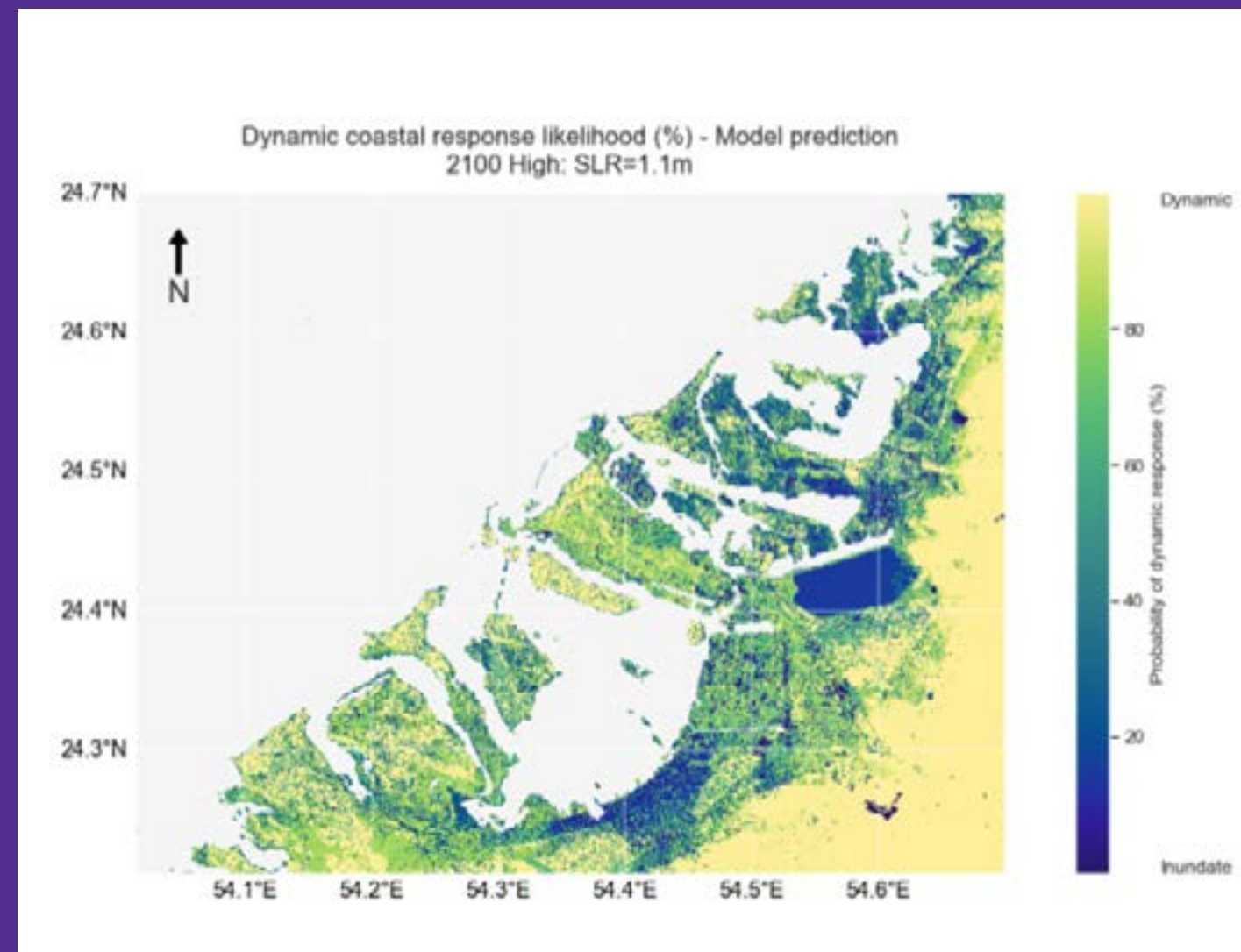

Model prediction of dynamic coastal response likelihood



Team meeting with student researchers and a Center for Sea Level Change researcher

Class of 2021



KACPER WOJCIECH LECKI

Major
Physics

Class of 2021



ARIYA CHALOEHTUEM

Major
Biology



Congratulations to Kacper Wojciech Lecki of the class of 2021, for being awarded The Piano Prize for exemplifying former Provost Fabio Piano's selfless devotion to science and to the wellbeing and excellence of our University.



Kacper after having collected his award

ACC.21
NEW DATES!
ATLANTA
May 15 - 17
AMERICAN COLLEGE OF CARDIOLOGY

Print this Page for Your Records Close Window

Control/Tracking Number: 21-A-17567-ACC
Activity: ACC Abstract
Current Date/Time: 12/3/2020 8:17:43 AM

SEVERE OBESITY IS ASSOCIATED WITH HDL PROTEOME CHANGES THAT RESOLVE WITH BARIATRIC SURGERY

Author Block: Ariya Chaloehtuem, Tomas Vaisar, Marcin Falis, Ruina Zhang, BingXue Lin, Manish Parikh, Jake Wimberger, Carissa Thornock, Jeffrey Berger, Edward Fisher, Florencia Schlamp, Sean Heffron, New York University Langone Health, New York, NY, USA, University of Washington, Seattle, WA, USA

Abstract:
Background: Obesity is an independent risk factor for Cardiovascular Disease (CVD) and is often associated with low HDL-cholesterol (HDL-C). While a causal association of HDL-C with CV outcomes is controversial, the importance of other measures of HDL such as protein content and function is increasingly recognized.
Methods: We performed targeted proteomic analyses of HDL isolated from 48 severely obese women before and 6 and 12 months after bariatric surgery, and matched lean control women. Data were assessed using RMANOVA and t-tests.
Results: Mean age was 33.9 ± 8.3 years, BMI 44.23 ± 6.5 kg/m² and weight 111 ± 16.6 kg. Subjects lost an average of 30.3 and 37.3 kg at 6 and 12 months, respectively. 19 HDL-associated proteins differed in concentration between lean and pre-op obese subjects. Notably relative to lean controls, HDL-associated apolipoprotein A4 (APOA4) and clusterin (CLU) – proteins reported reduced in stroke and insulin resistance – were lower in obese patients before surgery (Fig. A-B). Total HDL particles was not different between severely obese and lean women, and did not change after surgery (Fig. C). However, amounts of APOA4 and CLU per HDL particle increased, and by 12 months post-op they were no different from lean subjects.

Figure: Barplots of mean normalized concentrations for APOA4 (A), CLU (B) and total HDL particles (C) for lean controls and obese subjects at pre-op and 6 and 12 months post-op. Bars represent standard error. Pairwise t-tests performed after RMANOVA, at p-value < 0.05. ** indicates p-value < 0.01, *** indicates p-value < 0.001, n.s. indicates not significant.

Conclusion: Severely obese patients exhibit reduced amounts of HDL-associated APOA4 and CLU and bariatric surgery normalizes concentrations of the proteins. This finding may represent a mechanistic contribution for how bariatric surgery lowers CVD risk.

Abstract submitted to the American College of Cardiology's 70th Annual Scientific Session



Ariya Chaloehtuem was invited to present her research poster virtually at the American College of Cardiology's 70th Annual Scientific Session, May 15-17, 2021. Ariya's project 'Severe obesity is associated with HDL proteome changes that resolve with bariatric surgery' was presented as part of the 'Prevention and Health Promotion: Lipids 2' session.

Class of 2022



ODMAA BAYARAA

Major
Biology

Faculty Supervisor
Youssef Idaghdour

Class of 2022

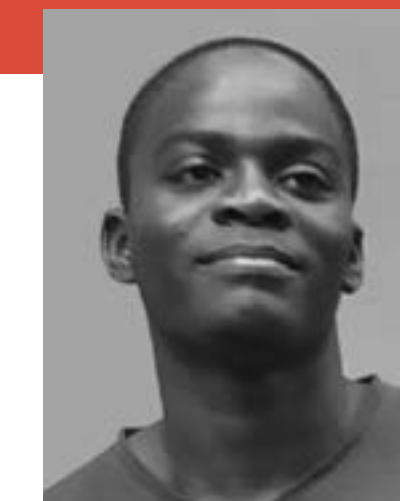

IBRAHIM SULEIMAN

Major
Mathematics

Faculty Supervisor
Ilya Spitkovsky

SINGLE-CELL GENOMICS OF HOST IMMUNE RESPONSE TO MALARIA

Malaria remains a significant global public health challenge, causing over 400,000 deaths annually, predominantly in children under the age of five. The Plasmodium parasite's ability to invade and evade the immune system makes mounting an efficient immune response difficult for the human host. However, past studies have shown that there is significant interindividual variation in the susceptibility and protective genetic effects of the host response. To this extent, we used matched design, single-cell RNAseq profiling of PBMCs, and whole-genome sequencing data of malarial children before and after natural *P. falciparum* infection in Burkina Faso, West Africa. We developed a protocol and analysis pipeline to determine infection and cell-type-specific expression quantitative trait loci (eQTLs) and test the hypothesis that some eQTLs and genotype-by-infection interactions controlling key genes will be generic, while others are specific. Our results revealed significant changes in cell-type composition and cell-type-specific genotype-by-infection interactions controlling key immunoregulatory genes in the host immune response to Malaria.

CIRCULAR NUMERICAL RANGES OF PARTIAL ISOMETRIES

The numerical range of an operator on a complex Hilbert space was introduced by Otto Toeplitz in a 1918 paper. This remarkable paper has since sparked a large body of work on the geometry of the numerical range. Some of these works have found applications in numerical analysis and quantum computing. My project concerned the circular numerical ranges of a special class of operators called partial isometries. These operators preserve the norms of vectors in the orthogonal complement of their kernel.

In a 2016 paper, Gau, Wang and Wu conjectured that if the numerical range of a partial isometry is a circular disk, then this disk must be centered at the origin. They proved this conjecture in at most 4 dimensions. Together with Professor Elias Wegert of the Institute of Applied Analysis TU Bergakademie Freiberg, we showed that this conjecture remains true in 5 dimensions using arguments based on divisibility criteria for a certain polynomial (the so-called Kippenhahn polynomial) associated with the operator in question. We also showed that the conjecture holds for all partial isometries of rank one and two regardless of the dimension.



Rabieh, S.; **Bayaraa, O.**; Romeo, E.; Amosa, P.; Calnek, K.; Idaghdour, Y.; Ochsenkühn, M.A.; Amin, S.A.; Goldstein, G. and Bromage, T.G. "MH-ICP-MS Analysis of the Freshwater and Saltwater Environmental Resources of Upolu Island, Samoa." *Molecules* 2020, 25, no. 21 (2020) 4871. DOI: 10.3390/molecules25214871



Class of 2022

UTTAM MISHRA

Major
Computer Science
Faculty Supervisor
Riyadh Baghdadi

CONVERTING NATURAL HUMAN LANGUAGE TO PYTHON CODE

To understand and generate the natural language, the large transformer models have been seen to be very effective. They have significantly achieved state-of-the-art results in different NLP tasks. The pre-trained models like GPT2, GPT3, BERT, T5 have had successful application in a wide range of domains. Given the fact that transformer-based models represent the natural language very well, it was highly effective for our task which involved generating code out of given texts. During the summer, we researched different potential models, and ultimately selected GPT2 as our baseline model. We replicated this pretrained model and made it work for our text to code generation task. This resulted in a goal of trying to improve upon and replicate the performance of the GPT2 model. Moving forward, we will attempt to collect fine-tuning data from GitHub and other relevant sites so that we can fine-tune our model. We will then attempt to understand if the additional fine-tuned dataset improves the performance of the current state of the art models.

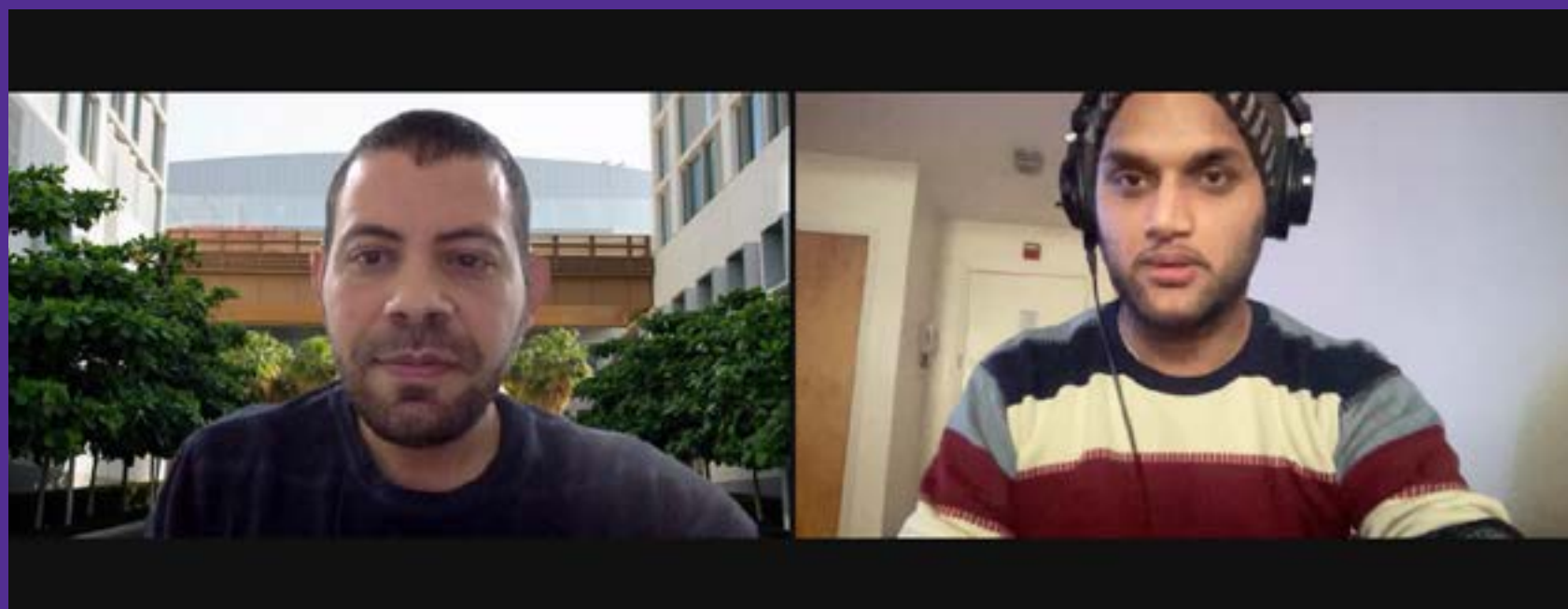

Virtual team meeting between Uttam and Professor Baghdadi

```

-- ukm202@b129-l-rb4792-cs:~/GPT2/auto_coding -- ssh -p 4410 ukm202@kindi.
LICENSE README.md data.py dataset demo.gif distilgpt2_fine_tuned_coder.zip evaluate.py hf_model.png icon.png interact.py model model.py requirements.txt train.py trainer.py
(base) [ukm202@b129-l-rb4792-cs auto_coding]$ mv distilgpt2_fine_tuned_coder.zip model
(base) [ukm202@b129-l-rb4792-cs auto_coding]$ cd model
(base) [ukm202@b129-l-rb4792-cs model]$ ls
distilgpt2_fine_tuned_coder.zip
(base) [ukm202@b129-l-rb4792-cs model]$ unzip distilgpt2_fine_tuned_coder.zip
Archive:  distilgpt2_fine_tuned_coder.zip
  creating: distilgpt2_fine_tuned_coder/
 extracting: distilgpt2_fine_tuned_coder/added_tokens.json
 inflating: distilgpt2_fine_tuned_coder/config.json
 extracting: distilgpt2_fine_tuned_coder/gpt_sh_config.json
 inflating: distilgpt2_fine_tuned_coder/log.out
 inflating: distilgpt2_fine_tuned_coder/merges.txt
 inflating: distilgpt2_fine_tuned_coder/pytorch_model.bin
 inflating: distilgpt2_fine_tuned_coder/special_tokens_map.json
 extracting: distilgpt2_fine_tuned_coder/tokenizer_config.json
 inflating: distilgpt2_fine_tuned_coder/vocab.json
(base) [ukm202@b129-l-rb4792-cs model]$ ls
distilgpt2_fine_tuned_coder  distilgpt2_fine_tuned_coder.zip
(base) [ukm202@b129-l-rb4792-cs model]$ python3 interact.py
python3: can't open file 'interact.py': [Errno 2] No such file or directory
(base) [ukm202@b129-l-rb4792-cs model]$ cd .
(base) [ukm202@b129-l-rb4792-cs model]$ ls
distilgpt2_fine_tuned_coder  distilgpt2_fine_tuned_coder.zip
(base) [ukm202@b129-l-rb4792-cs model]$ cd..
-bash: cd..: command not found
(base) [ukm202@b129-l-rb4792-cs model]$ cd ..
(base) [ukm202@b129-l-rb4792-cs auto_coding]$ ls
LICENSE README.md data.py dataset demo.gif evaluate.py hf_model.png icon.png interact.py model model.py requirements.txt train.py trainer.py
(base) [ukm202@b129-l-rb4792-cs auto_coding]$ python3 interact.py
Traceback (most recent call last):
  File "interact.py", line 20, in <module>
    model = GPT2LMHeadModel.from_pretrained(args.model_path)
  File "/home/ukm202/anaconda3/lib/python3.8/site-packages/transformers/modeling_utils.py", line 1260, in from_pretrained
    config, model_kwargs = cls.config_class.from_pretrained(
  File "/home/ukm202/anaconda3/lib/python3.8/site-packages/transformers/configuration_utils.py", line 501, in from_pretrained
    config_dict, kwargs = cls.get_config_dict(pretrained_model_name_or_path, **kwargs)
  File "/home/ukm202/anaconda3/lib/python3.8/site-packages/transformers/configuration_utils.py", line 550, in get_config_dict
    configuration_file = get_configuration_file(
  File "/home/ukm202/anaconda3/lib/python3.8/site-packages/transformers/configuration_utils.py", line 841, in get_configuration_file
    all_files = get_list_of_files(
  File "/home/ukm202/anaconda3/lib/python3.8/site-packages/transformers/file_utils.py", line 1952, in get_list_of_files
    return list_repo_files(path_or_repo, revision=revision, token=token)
  File "/home/ukm202/anaconda3/lib/python3.8/site-packages/huggingface_hub/hf_api.py", line 601, in list_repo_files
    info = self.model_info(
  File "/home/ukm202/anaconda3/lib/python3.8/site-packages/huggingface_hub/hf_api.py", line 585, in model_info
    r.raise_for_status()
  File "/home/ukm202/anaconda3/lib/python3.8/site-packages/requests/models.py", line 943, in raise_for_status
    raise HTTPError(http_error_msg, response=self)
requests.exceptions.HTTPError: 404 Client Error: Not Found for url: https://huggingface.co/api/models/model/gpt2_medium_fine_tuned_coder
(base) [ukm202@b129-l-rb4792-cs auto_coding]$ ls
LICENSE README.md data.py dataset demo.gif evaluate.py hf_model.png icon.png interact.py model model.py requirements.txt train.py trainer.py
(base) [ukm202@b129-l-rb4792-cs auto_coding]$ wget https://ucdcs-student.ucd.ie/~cwang/autocoder/gpt2_medium_fine_tuned_coder.zip
--2021-12-10 18:20:36-- https://ucdcs-student.ucd.ie/~cwang/autocoder/gpt2_medium_fine_tuned_coder.zip
Resolving ucdcs-student.ucd.ie (ucdcs-student.ucd.ie)... 193.1.132.94
Connecting to ucdcs-student.ucd.ie (ucdcs-student.ucd.ie)|193.1.132.94|:443... connected.
HTTP request sent, awaiting response... 200 OK
Length: 1319581171 (1.2G) [application/zip]
Saving to: 'gpt2_medium_fine_tuned_coder.zip'

gpt2_medium_fine_tuned_coder.zip  99%[=====] 1.22G 2.62MB/s  eta 2s

```

Riyadh Baghdadi

Debugging and updating progress in weekly meetings

36



SOCIAL SCIENCE



Class of 2021

DINO KOLONIC

Major
Political ScienceFaculty Supervisor
Joan Barceló

MICRO-LEVEL EFFECTS OF EXPOSURE TO WARTIME VIOLENCE

In the wake of the “micro-level revolution” in conflict research, scholars have produced a wealth of rigorous research that credibly estimates the consequences of violent conflict on a number of political attitudes and behaviors. Despite sizable literature, the jury is still out on what the effects of wartime violence are on political attitudes and behavior. This summer research project offered a systematic evaluation of the evidence that has thus far been reported in empirical studies. To this end, we reviewed over 300 estimates derived from 110 studies of the micro-level effects of exposure to wartime violence on several key outcomes: peace attitudes, support for democratic regimes, vote choice, ethnic and national identities, political engagement, civic engagement, and trust.

I was responsible for coding every study into a master spreadsheet that identifies about 70 features of the study (e.g., sample size, outcomes studied, level of aggregation, violence measure). I was also responsible for obtaining the original dataset, codebook, and replication files for each study, and systematically organizing them in preparation for conducting meta-analysis regressions.

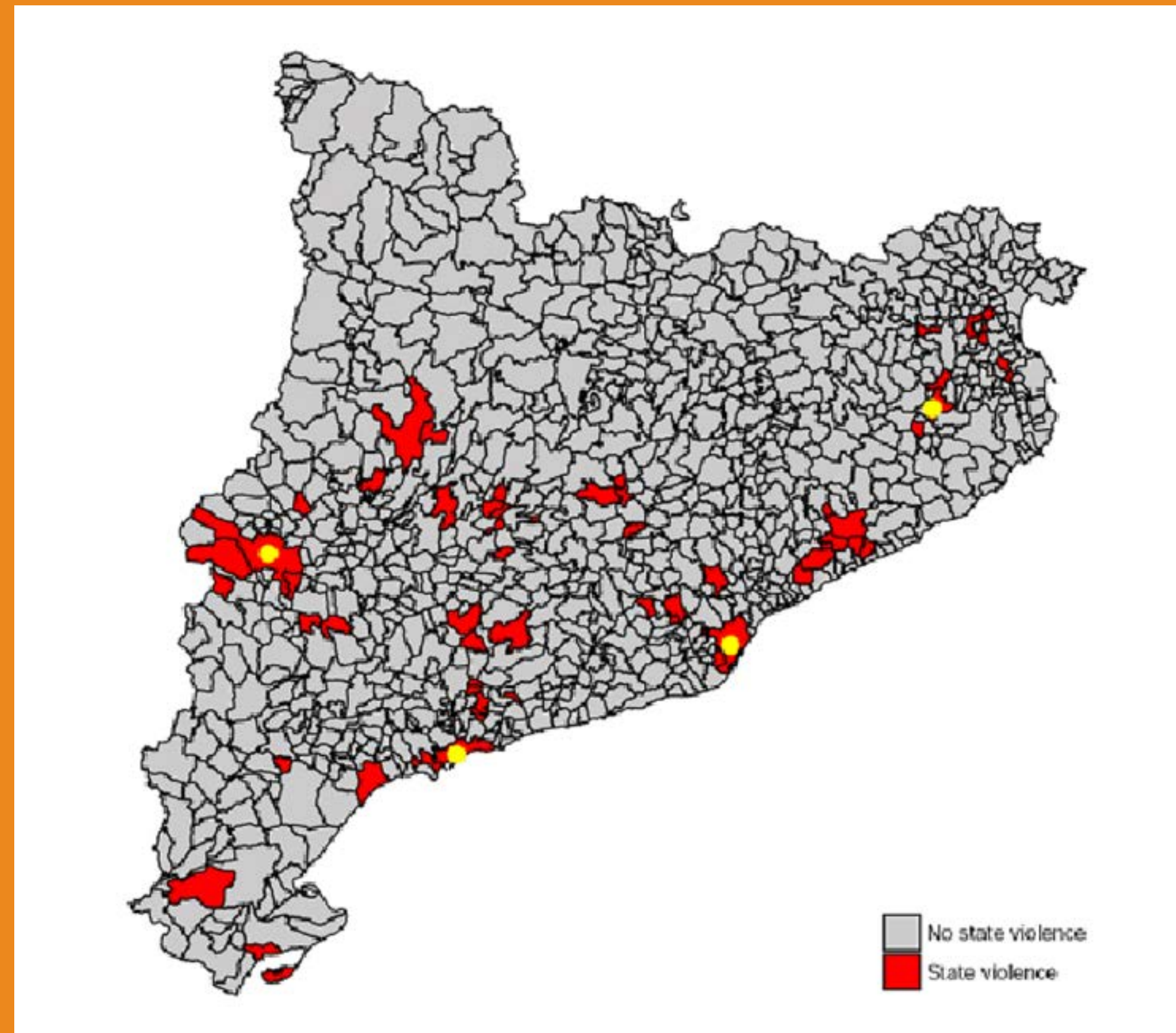

Map of state violence in Catalonia. The map shows the areas of the Catalan region that suffered from violence by the Spanish police on 1 October 2017. Yellow circles show the location of the province capitals where the major Spanish police headquarters are located. Source: DOI:10.1177/2053168018781747

Class of 2023

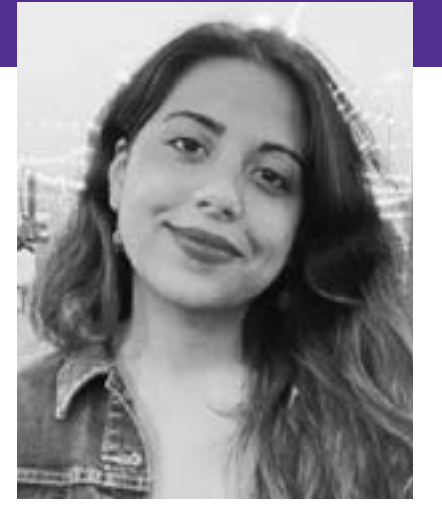

SARAH AHMAD KHAN

Major
EconomicsFaculty Supervisor
Morgan Hardy

SMALL ENTERPRISE EMERGENCY FINANCIAL ASSISTANCE (SEEFA)

While a majority of workers in low-income countries are own-account, a sizeable share are wage employed in informal firms. For this research project we aimed to study if the logic of firm assistance and job retention programs in the formal sector apply to firms and wage employees in the informal sector. Is firm survival sufficient to avoid job destruction or must assistance take the form of implicit or explicit pass-through to workers? We used randomised income transfers to firms and workers to test implementation modalities for small firm emergency assistance, measuring effects on firm survival, job retention, wages, and firm owner and worker income smoothing. We aimed to provide scalable policy evidence, and to use the experiment to explore deeper questions about whether (and when, and, to what effect) informal firms insure their workers against shocks.



Class of 2021

AMINA BAŠIĆ

Major
Social Research and Public Policy

Faculty Supervisor
Jemima Frimpong

PATIENT PREFERENCES FOR OPIOID USE DISORDER TREATMENT: A DISCRETE CHOICE EXPERIMENT

Despite high levels of HIV-HCV coinfection, and increasing calls for the integration of HIV and HCV services with substance use disorder treatment, efforts to introduce rapid testing to substance use treatment programs have mostly emphasized HIV testing. In a recent trial in New York City, offering “bundled” rapid HIV and HCV tests increased the proportion of patients who learned both their HIV and HCV test from 19% to 69%. This research project investigated attitudes towards joint rapid HIV and HCV testing among two groups of patients: those with a substance use disorder and are currently in a substance use treatment programs; and those with a substance use disorder who have never been in treatment. In order to understand the patient preferences, I worked on creating a discrete choice experiment embedded in the survey that is being distributed to the study participants. Ultimately, the goal of the study was to define a package of attributes that will facilitate the implementation of bundled rapid HIV and HCV testing in substance use disorder treatment programs. Understanding patient preferences can also help develop new interventions and policies to increase uptake of testing and awareness of HIV/HCV infection status.



Class of 2021

YAO XU

Major
Social Research and Public Policy

Faculty Supervisor
Kinga Makovi

REPUBLICANS DISCRIMINATED AGAINST CHINESE AMERICANS THROUGHOUT THE COVID-19 PANDEMIC

Anti-Asian sentiment and hate crimes in the United States spiked during the COVID-19 pandemic. Individuals with connections to China, the first country that reported clusters of COVID-19 cases, are likely to be especially affected. The project investigated unequal treatment towards Chinese-born individuals living in the United States as compared to their US-born counterparts using an experimental approach, more specifically with the give-or-take dictator game. Relying on a nationally representative sample and two survey waves fielded in May and October 2020, the work contributes to the existing literature by examining behavioral evidence of unequal treatment and the associations between various COVID-19 related vulnerabilities and mistreatment. My responsibility involved data cleaning, analysis, and visualization for the methods and results sections.

Class of 2023

KHOI NGO

Major
Political Science

Faculty Supervisor
Jonathan Andrew Harris



STUDIES OF ELECTIONS AND ELECTORAL FRAUD

For political institutions and democracies to persist and remain stable, electoral processes play an undeniable role in the peaceful and legitimate transitions of power. As countries around the world democratize and attempt to refine their electoral systems, studies of elections and electoral fraud shed light on how scholars can help legislators and governments strengthen the quality of their elections. I worked with Professor J. Andrew Harris on multiple projects, all of which focus on Sub-Saharan Africa. In academic year 2020-2021, I worked primarily on two projects with Professor J. Andrew Harris, one on Kenya's 2013 presidential election (as a Research Assistant) and one on Malawi's 2019 presidential election (as a co-author). The former was recently published on Electoral Studies journal, while the latter is an ongoing project that adopts rigorous quantitative methods to detect mischief versus mistakes in vote counting.



Class of 2021

HANNAH KASAK-GLIBOFF

Major
Social Research and Public Policy
Faculty Supervisor
Kinga Makovi

THE EFFECTS OF IDEOLOGICAL VALUE FRAMING AND SYMBOLIC RACISM ON PRO-ENVIRONMENTAL BEHAVIOR

Our project centered around environmental action in the United States and looked at ways in which racism and political ideologies influence peoples' willingness to support environmental causes. We started with an experimental survey to test the persuasiveness of different environmental messages to liberals and conservatives, and followed up with a qualitative interview component. The experimental survey varied messages by utilizing liberal or conservative value framing and by implying that environmental impacts affect Black or White families. In the qualitative interviews, we hoped to expand upon the experimental survey results by considering respondents economic priorities and understanding of environmental issues. The goal of the project was to promote environmental justice by finding ways to garner support among conservatives and liberals alike in order to enable swifter environmental action and relief of environmental inequality. We hope that our project will have applications in environmental messaging and help create a strategic framework for environmental activism. Our experimental survey project has been published in Nature's Scientific Reports.



Makovi, K. and Kasak-Gliboff, H. "The effects of ideological value framing and symbolic racism on pro-environmental behavior." *Scientific Reports*, 11, no. 22189 (2021). DOI: 10.1038/s41598-021-00329-z



Class of 2023

ZHONG CHEN (ZACK) TAN

Major
Social Research and Public Policy
Faculty Supervisor
Melanie Meng Xue

WOMEN AND ASYLUMS

I compiled systematic reviews and databases in English and Chinese for two different research projects - one on the gender dynamics of mental health in 19th century England, and another on Chinese economic history. The project on gender dynamics of mental health became my primary project, which involved collecting asylum records and newspaper reports on asylums across the UK to examine popular understandings of insanity; compiling data sources on the use of drugs to alleviate symptoms of depression, to examine the medicalization of insanity in society; and collating literature reviews on divorce laws and the gender composition of asylum patients that reveal gender biases in the definitions of insanity in 19th century Britain. The secondary research project on long-term Chinese economic history involved compiling literature reviews on the relationship between monsoon climates and culture, summarizing English and Mandarin Chinese articles to examine the existing knowledge base on the topic.

Class of 2021



ABDUL KAREEM KAMRAN

Major
Economics and Business Studies
Faculty Supervisor
Heitor Pellegrina



Congratulations to Abdul Kareem Kamran, who was awarded the Social Science Capstone Award for his research on social inequality in Airbnb host earnings. He used the profile photos of Airbnb hosts from five different US cities and information about the demand and price of listings to construct a dataset which he could analyse. Abdul was able to conclude that there was "statistically significant evidence of race-based differences in earnings on Airbnb." His Capstone project was supervised by Heitor Pellegrina.



I was involved in every single aspect of research from ideation and data collection to writing my final thesis. I learned the importance of project management. It was crucial for me to take a step back every now and then to look at the bigger picture and figure out where I am and where I am headed with this project. Doing that allowed me to focus and prioritize my tasks better. There were days where I would barely make any progress and felt completely unmotivated to work and other days where I would have massive breakthroughs. I think it's important to remember that it's a marathon not a sprint - and to be genuinely interested in the topic you choose to work on.

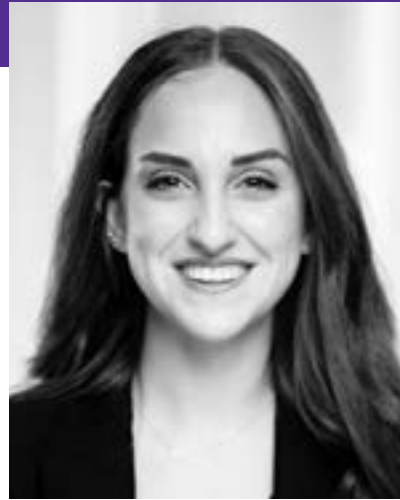

Class of 2021

SALMA SOLIMAN

Major
Economics
 Faculty Supervisor
Morgan Hardy

ANALYSIS TO CLOSE THE GENDER PROFITABILITY GAP

As the body of evidence on gender gaps rapidly expands, there is an increasing need for a common framework and rigorous “stock taking” of what has already been investigated and where the highest value would be for any potential new work. The research project I engaged in during the summer focused on understanding the effect of female firm ownership on firm performance on the global level and national level in Ethiopia. I assisted in the process of data collection and preparation for the analysis on the global level. This undertook communicating with third parties to gain access to the data, carefully preparing the data for analysis under a set data cleaning manual, and aggregating the data to produce a global micro-level dataset.



Congratulations to Salma Soliman for winning the Social Science best Capstone Award in Economics. Her research explored trends and predictors of the gender gap in financial inclusion. Salma found that while overall financial inclusion is improving globally, the gender gap is actually widening, driven by country-level cultural factors. Salma’s Capstone project was supervised by Morgan Hardy.

“My Economics degree has taught me to think critically about social science issues that are at the forefront of economic development. Because I am particularly interested in the intersection of data analysis, economic development, and gender discrimination, I was very eager to combine these fields in my Capstone project. The process of creating this Capstone has grown my appreciation and interest in empirically-driven research and its impact on policy.

Class of 2021



AWAHNEE MENDIS

Major
Social Research and Public Policy
 Faculty Supervisor
Onoso Imoagene

MIGRATION BETWEEN AFRICA AND CHINA

I spent my summer researching the migrant flows and the nature of migrant experiences in Africa and China. The first half of this research comprised of an in-depth study of the existing literature on the African migrants who work with permanently or temporarily in China, most often in Guangzhou. I uncovered a wealth of knowledge about this group, including their experiences with law enforcement, how they maintain cultural identities abroad, their business and work lives, and their professional and personal interactions with wider Chinese society. I then analysed what I found and prepared a report which identified gaps in the research, such as the need for a focus on the experiences of female traders. The second half of my research was an exploration of the literature to better understand the migrant experiences of Chinese migrants in different African countries, for which I followed the same process as above. This experience provided me with a chance to critically analyse data, and learn, a wealth of knowledge about South-South migration in the 20th and 21st centuries.



INTERDISCIPLINARY

Faculty Supervisors **Dimitra Atri** and **K. R. Sreenivasan**

MARS RESEARCH GROUP

The Center for Space Science (CSS) at NYU Abu Dhabi is helping position the UAE as a world center for scientific discovery and innovation. In summer 2021, a number of students worked at the Mars Research Group, within CSS. The group, led by Dimitra Atri and K. R. Sreenivasan, is interested in the atmosphere of Mars, its surface and subsurface chemistry, and exploring its present and past habitability.



KHALIFA UNIVERSITY
Class of 2021

**AHMED
ALHANTOOBI**

Major
Aerospace Engineering



NYU ABU DHABI
Class of 2023

**AARYAN
SHARMA**

Major
Physics



NYU NEW YORK
Class of 2024

**MEHNAZ
HALIMA**

Major
Biology

We worked on the Mars atmosphere project, which included investigating how space weather impacts the Martian atmosphere. Using a combination of numerical modeling and data from space missions, the goal was to understand space weather-induced changes in atmospheric chemistry and escape rates. Data from the UAE’s Hope mission will be used to complement ongoing research with NASA’s MAVEN and Curiosity missions. AI-based techniques for data analysis are being developed from multiple missions to take advantage of large datasets and obtain a comprehensive picture of the planet.

I spent the summer working on the Mars astronauts project. All major spacefaring nations, including the UAE (Mars 2117) are thinking about crewed missions to the planet in future. My work involved assisting the group in investigating the impact of radiation on astronaut health using a combination of numerical modeling and medical data.



Thais Montes and Valles Marineris
EMM/EXI/Dimitra Atri/NYU Abu Dhabi Center for Space Science



The Tharsis region of Mars featuring Olympus Mons, the tallest mountain in the Solar System along with three prominent shield volcanoes known as Tharsis Montes
Credit: Emirates Mars Mission/EXI/Dimitra Atri/NYU Abu Dhabi Center for Space Science



Valles Marineris, a vast canyon system that runs along the Martian equator. It is about 4000 km long, 200 km wide and up to 7 km deep
Credit: EMM/EXI/Dimitra Atri/NYU Abu Dhabi Center for Space Science

Faculty Supervisors Ibrahim Chehade, Rafael Song and Andras Gyorgy

**HA-NEUL YU | ABIGAIL AMA KOOMSON | ARYA GAUTAM | LINA UTENOVA | SAKURA GRANT | ZERINA RAHIC
YASMINE EL HAJJ | ABHAY MENON | BRIAN QUARTEY | KENECHUKWU EZEIFEMEELU | MAYA FAYED | MA-SUM ABDUL-HAMID
BARAA AL JORF | TEDI HONDRO | UMER BIN LIAQAT | MICHELLE ANNE HUGHES | ADRIAN JOSHUA VILLANUEVA**

NYUAD IGEM

The iGEM Competition (administered by the iGEM Foundation) gives students the opportunity to push the boundaries of synthetic biology by tackling everyday issues facing the world. Made up of primarily university students, multidisciplinary teams work together to design, build, test, and measure a system of their own design using interchangeable biological parts and standard molecular biology techniques. Every year nearly 6,000 people dedicate their summer to iGEM and then come together in the fall to present their work and compete at the annual Jamboree.

The NYUAD iGEM team worked on developing a fully fledged rapid, portable, cheap, easy to use, field fungal diagnostic device. The project tackles different components that go into developing a point of care diagnostic device: sample collection, extraction and purification, amplification, detection, reaction medium, reporting, sensing, and data management. The end product is targeted to be used for monitoring the spread of infectious animal diseases such as chytridiomycosis which has been the main driver behind the amphibian decline. During last year's iGEM competition, the team won a gold medal.



Members of the iGem team hard at work within the lab.



RESEARCH FELLOWSHIP PROGRAM



LAURA KARPAUSKAITE

Faculty Supervisors
Mazin Magzoub and President Andrew D. Hamilton

TARGETED DELIVERY OF ALPHA-HELIX MIMETICS TO INHIBIT MUTANT P53 AGGREGATION AND RESTORE TUMOR SUPPRESSOR FUNCTION IN PANCREATIC CARCINOMA

During the fellowship I investigated novel cancer therapeutics targeting protein aggregation and their delivery by nanocarrier systems. We determined that small molecules, synthesised for amyloid proteins (e.g. A-beta, IAPP), are able to potently inhibit cancer cell growth and induce p53-mediated cell death. I published my findings in a scientific journal. From September 2021, I will be pursuing a PhD in Biomedical Sciences at the Francis Crick Institute and Imperial College London focusing on protein translation and molecular chaperones.





Palanikumar, L., Karpauskaite, L., Al-Sayegh, M. et al. Protein mimetic amyloid inhibitor potently abrogates cancer-associated mutant p53 aggregation and restores tumor suppressor function. *Nat Commun* 12, 3962 (2021). <https://doi.org/10.1038/s41467-021-23985-1>

“The Post-graduation Research Fellowship allowed me to have a taste of a researcher’s career and convinced me to pursue graduate studies.

Article | [Open Access](#) | [Published: 25 June 2021](#)

Protein mimetic amyloid inhibitor potently abrogates cancer-associated mutant p53 aggregation and restores tumor suppressor function

[L. Palanikumar](#), [Laura Karpauskaite](#), [Mohamed Al-Sayegh](#), [Ibrahim Chehade](#), [Maheen Alam](#), [Sarah Hassan](#), [Debabrata Maity](#), [Liaqat Ali](#), [Mona Kalmouni](#), [Yamanappa Hunashal](#), [Jemil Ahmed](#), [Tatiana Houhou](#), [Shake Karapetyan](#), [Zackary Falls](#), [Ram Samudrala](#), [Renu Pasricha](#), [Gennaro Esposito](#), [Ahmed J. Afzal](#), [Andrew D. Hamilton](#) , [Sunil Kumar](#)  & [Mazin Magzoub](#) 

Nature Communications 12, Article number: 3962 (2021) | [Cite this article](#)

11k Accesses | 66 Altmetric | [Metrics](#)

Abstract

Missense mutations in p53 are severely deleterious and occur in over 50% of all human cancers. The majority of these mutations are located in the inherently unstable DNA-binding domain (DBD), many of which destabilize the domain further and expose its aggregation-prone hydrophobic core, prompting self-assembly of mutant p53 into inactive cytosolic amyloid-like aggregates. Screening an oligopyridylamide library, previously shown to inhibit amyloid formation associated with Alzheimer’s disease and type II diabetes, identified a tripyridylamide, ADH-6, that abrogates self-assembly of the aggregation-nucleating subdomain of mutant p53 DBD. Moreover, ADH-6 targets and dissociates mutant p53 aggregates in human cancer cells, which restores p53’s transcriptional activity, leading to cell cycle arrest and apoptosis. Notably, ADH-6 treatment effectively shrinks xenografts harboring mutant p53, while exhibiting no toxicity to healthy tissue, thereby substantially prolonging survival. This study demonstrates the successful application of a bona fide small-molecule amyloid inhibitor as a potent anticancer agent.



MELISA DEMIROVIC

Faculty Supervisor
Blaine Robbins

GENDER, RACE, INFORMATION, AND NEGOTIATION

During the course of the fellowship program, I conducted two research projects examining fairness of earnings and attitudes toward negotiation. Focusing on the effects of gender and income inequality, I studied the contextual sources of perceptions and attitudes, as well as the mechanisms through which gender affects decision-making in negotiations. I used experimental methods to answer my research questions, including a multifactorial survey experiment and a behavioral experiment. In October 2021, I will be pursuing a Master of Science in Sociology and Social Research at the University of Cologne in Germany.



SEONGYOON KIM

Faculty Supervisor
Morgan Hardy

WHO 'YA GHANA TRUST

My research project with collaborators in NYU Abu Dhabi, IZA, and CERGE-EI carefully investigates a sample of garment makers in Ghana and the social networks between the members of the sample. I study whether firm owners work for/hire each other, and whether they are willing to pay for information regarding which members of the sample are willing to work for/hire them. Preliminary findings suggest that firms are willing to pay for information regarding those who are willing to hire them and those who are willing to work for them. I also find that the firms who purchased such information are more likely to be open and experience an increase in profits after the first peak of the COVID-19 pandemic. I will be building on my research and knowledge by pursuing a PhD in Economics at the University of Michigan.



HAFSA AHMED

Faculty Supervisor
Marzia Balzani

BODIES IN DIFFERENCE: POLICIES, PROGRAMS, AND PEOPLE IN THE UAE DISABILITY LANDSCAPE

My research documented and analyzed disability policies and programs in the UAE from the conception of the first federal law on disabilities in 2006. Adopting theory from anthropology of policy and the capabilities approach (Amartya Sen), I utilized discourse analysis to understand how the UAE's policy focus has transformed in the last 15 years, from care and cure to human rights and empowerment for people with disabilities. I complemented my policy analysis with ethnographic work and captured insights from people of determination, their families, grassroots activists, and policymakers on the disabled experience in the UAE. My work culminated in a series of empirical insights on the development of disability strategy and policymaking in the Emirates, and policy recommendations on driving greater participant-driven inclusion across all spheres of the UAE society. As a Fellow, I have published research blogs and podcasts with the Al Qasimi Foundation for Policy Research, and presented my work at conferences in the UAE, US, and UK.



PRAJNA SONI

Faculty Supervisor
Saif Jabari

EVALUATION OF RECOMMENDATION SYSTEM ALGORITHMS FOR BIAS PROPAGATION AND USER ASSIMILATION

During the fellowship, I worked on a project investigating the confounding effect of feedback loop algorithms in recommender systems. Specifically, I was evaluating bias propagation and user assimilation in user communities that interacted with recommender systems over a period of time. This involved curating scripts and notebooks to set up a public repository of our simulation environment and writing a paper that will be reviewed for publication later this year. Moving forward, I am continuing my research interests in the field through an SM in Technology and Policy with EECS at MIT.

“The fellowship allowed me to explore two of my research interests, helping me gain clarity on what I wanted to pursue during graduate school, and equipped me with valuable research experience. I will build upon my fellowship experience in my Master’s program at MIT as I continue to pursue my interests in AI policy and explainable ML.



FARAH SHAHBAZ

Faculty Supervisor
Kemal Celik

LIFE CYCLE ASSESSMENT OF REACTIVE MGO CEMENT PRODUCED FROM REJECT BRINE IN THE UAE

Portland cement, as a single material industry, contributes to significant CO₂ emissions on a global scale. Reactive MgO cement is considered as a sustainable cement alternative to Portland cement. During my fellowship year, I joined AMBER lab’s ongoing project to produce Reactive MgO from reject brine. My research project focused on optimizing the lab scale production of Reactive MgO synthesized from reject brine using different procedures. I evaluated the environmental impacts of the lab scale production using a life cycle assessment framework to optimize the best environmentally performing procedure. My research findings show promising potential to scale up the production of Reactive MgO cement synthesized from reject brine in the UAE.



Farah synthesizing MgO cement from reject brine in AMBER Lab



SARA ALANIS

Faculty Supervisors
John Burt and Kemal Celik

(FUNDED BY CITIES)

ENHANCING URBAN SEAWALL SUSTAINABILITY USING ECOLOGICAL ENGINEERING

Unprecedented scales of coastal urban developments along with the artificialization of the shorelines bring additional pressures on the marine ecosystem, biodiversity, and the environment. Coastal eco-engineering suggests that artificial coastal structures with higher surface complexity support intertidal and subtidal communities with higher diversity and abundance. In this research, I produced concrete panels to better understand the effect of surface texture from micrometer to centimeter-scale on the long-term recruitment of intertidal and subtidal benthic organisms. This research allowed me a greater understanding that civil infrastructure does not exist in isolation; it has a direct impact on the surrounding soil, air, water, and living organisms. I will continue my research interests in resilient and nature-inspired infrastructure through an MS in Energy, Civil Infrastructure and Climate at UC Berkeley.

TRANSFORMATIVE EDUCATION IN THE LIBERAL ARTS

From January 2020 to January 2021, I served as the inaugural post-graduation research fellow of the Hilary Ballou Center for Teaching and Learning. In this role I worked closely with the Center Director to support faculty in their teaching efforts, while simultaneously spearheading my own research agenda on transformative education in the liberal arts. I successfully completed a research project on Transformative Courses at NYUAD. Furthermore, I researched, in collaboration with my supervisor, the vital role of Centers for Teaching and Learning (CTLs) in ensuring academic continuity during the COVID-19 pandemic.

ALEXANDRA URBANIKOVA

Faculty Supervisor
Nancy Gleason



“The most rewarding aspect of this experience has been gaining familiarity with intricacies of educational research including the use of appropriate methodologies and methods, and discovering complexities presented by the launch of a new department within the institution.”



AJ ABDUJABBOROV

Faculty Supervisor
Kartik K. Sreenivasan

ESTIMATING MEMORY-RELATED BRAIN ACTIVITY IN HUMANS USING FUNCTIONAL MRI

Working memory (WM) is the indispensable cognitive ability to maintain representations over short periods of time. As such, researchers are interested in identifying its neurobiological bases using the spatially precise and non-invasive brain imaging modality of Magnetic Resonance Imaging (MRI). However, the complex design of WM experimental paradigms and the nature of MRI pose methodological challenges for this investigation. I employed computer simulations and experimental data to identify methods optimal for overcoming these challenges with the end goal of advancing WM research.



NADA AMMAGUI

Faculty Supervisor
Deborah Kapchan

SHAPING SHARJAH: A DIGITAL GEOSPATIAL ANALYSIS OF ART EXHIBITIONS IN OLD SHARJAH

My fellowship project involved tracing the historical impact of the Sharjah Biennial, an internationally-acclaimed art exhibition taking place every two years across various parts of Sharjah, by creating digital spatial visualizations of artworks and installations at the Biennial from 1993-2019. To do this, I manually input hundreds of artworks and related information into spreadsheets which are in turn transformed into digital maps. I was able to show how the proliferation of installations around various historically important sites across the emirate help to shape the aesthetic preferences of visitors and residents alike.



Torkwase Dyson's I Belong to the Distance at Sharjah Biennial 14_Taken by Nada Ammagui



Library at The Flying Saucer, Sharjah



The invisible enemy should not exist (2007-ongoing) by Michael Rakowitz at the Unsettled Objects exhibition at Sharjah Art Foundation, March 2021

NYU Abu Dhabi would like to congratulate the following recipients of the AY 21-22 research fellowships. The research fellows will take part in a year of full-time, independent and intensive research from September 1, 2021 - August 31, 2022.

Faculty Supervisors **Robert Parthesius and Alia Yunis**

NICCOLÒ ACRAM CAPPELLETTO

WHAT GOES INTO A UNESCO NOMINATION? ALTERNATIVE HERITAGE PRACTICES IN ERITREA AND UAE

Faculty Supervisor **Kinga Makovi**

YAO XU

WHEN THE OVERSEAS CHINESE "GO BACK TO THEIR COUNTRY": INVESTIGATING UNEQUAL TREATMENT TOWARD RETURNEES IN MAINLAND CHINA AMID THE PANDEMIC

Faculty Supervisor **Nancy Gleason**

KEZIAH JOHNSON

(JANUARY 2020-JANUARY 2021)

THE IMPACT & INFLUENCE OF TECHNOLOGY SUPPORTED PEDAGOGY IN HIGHER EDUCATION: NYUAD CASE STUDY

Faculty Supervisor **Ali Diabat**

SUNGMIN SOHN

OPTIMIZATION FOR DRONE-TRUCK COMBINED OPERATIONS ROUTING SYNCHRONIZATION PROBLEM

Faculty Supervisor **Andrea Macciò**

KACPER LECKI

IMPACT OF WANDERING BLACK HOLES ON GALAXY FORMATION: IMPLEMENTATION OF GRAVITATIONAL RECOIL IN THE NIHAO PROJECT

Faculty Supervisor **Piergiorgio Percipalle**

OSCAR SAPKOTA

THE ROLE OF NUCLEAR MYOSIN 1 IN REGULATING MITOCHONDRIAL GENE EXPRESSION AND NEUROGENESIS

Faculty Supervisor **Joan Barceló**

KESHANA RATNASINGHAM

THE LEGACIES OF EXPOSURE TO IN-GROUP VIOLENCE ON ETHNIC RECONCILIATION: EVIDENCE FROM SRI LANKA

Faculty Supervisors **May Al-Dabbagh and Surabhi Sharma**

LUBNAH ANSARI

LOVE IN THE TIME OF LOVE-JIHAD: HINDU-MUSLIM MARRIAGES IN INDIA

Faculty Supervisor **Olivia Cheung**

NAWAL ALJAEEDI

THE CONFIGURATION EFFECT OF MUSICAL NOTATION READING

Faculty Supervisors **Heather Dewey-Hagborg and Joerg Blumtritt**

VINCE NGUYEN

FUNDED BY CITIES

INTERFACING LOW-COST AIR QUALITY SENSORS WITH APPLE WATCH: A SELF-QUANTIFIED APPROACH TO RAISING AWARENESS OF AIR POLLUTION

Faculty Supervisor **Nancy Gleason**

KATHARINA KLAUNIG

CLASS PARTICIPATION OF FIRST-YEAR STUDENTS AT NYUAD

Supervisor **Fatiah D. Touray**

THAIS THOMAS

CLASSROOM COMFORT?: AN EXAMINATION OF STUDENT RESPONSES TO FACULTY RACIAL AND ETHNIC DIVERSITY



FACULTY SUPERVISORS

WITH THANKS TO ALL FACULTY AND ACADEMIC STAFF WHO SUPERVISED NYU ABU DHABI UNDERGRADUATE RESEARCHERS IN ACADEMIC YEAR 2020-2021.

Those featured in this publication are listed below:

AASHISH JHA

Assistant Professor of Biology; Global Network Assistant Professor of Biology, NYU Abu Dhabi

ALIA YUNIS

Visiting Associate Professor of Film and Heritage Studies, NYU Abu Dhabi

ALI DIABAT

Professor of Civil and Urban Engineering, NYU Abu Dhabi

ANDRAS GYORGY

Assistant Professor of Electrical Engineering and Bioengineering, NYU Abu Dhabi

ANDREA MACCIÒ

Associate Professor of Physics, NYU Abu Dhabi

ANDREW D. HAMILTON

President of New York University

ANTJE VON SUCHODOLETZ

Assistant Professor of Psychology, NYU Abu Dhabi

BIN FANG

Assistant Professor, Tsinghua University

BLAINE ROBBINS

Assistant Professor of Social Research and Public Policy, NYU Abu Dhabi

CARLOS GUEDES

Associate Professor of Music, NYU Abu Dhabi

CHRIS OCKER

Professor of Medieval and Early Modern Studies, Australian Catholic University; Humanities Research Fellow, NYU Abu Dhabi

DANIEL JOHNSON

Assistant Professor of Civil and Urban Engineering, NYU Abu Dhabi

DAVID HOLLAND

Professor of Mathematics, Center for Atmosphere Ocean Science, Courant Institute of Mathematical Sciences, NYU Abu Dhabi; Affiliated Faculty and Principal Investigator for the Center for Sea Level Change, NYU Abu Dhabi

DAVID WRISLEY

Associate Professor of Digital Humanities, NYU Abu Dhabi

DEBORAH KAPCHAN

Professor of Performance Studies, NYU New York and NYU Abu Dhabi

DJELLEL DIFALLAH

Assistant Professor of Computer Science, NYU Abu Dhabi

EDUARDO CHIELLE

Postdoctoral Associate, NYU Abu Dhabi

ENRICO BERTINI

Associate Professor of Computer Science and Engineering, NYU Abu Dhabi

FATIAH D. TOURAY

Senior Director of Inclusion and Equity, NYU Abu Dhabi

FIONA KIDD

Co-Program Head, Art and Art History; Assistant Professor of History and Art History; Global Network Assistant Professor in the Study of the Ancient World, NYU Abu Dhabi

HANAN SALAM

Assistant Professor of Computer Science, NYU Abu Dhabi

HEATHER DEWEY-HAGBORG

Visiting Assistant Professor, NYU Abu Dhabi

HEITOR PELLEGRINA

Assistant Professor of Economics, NYU Abu Dhabi

HIMADRI MUKHERJEE

Postdoctoral Associate, NYU Abu Dhabi

IBRAHIM CHEHADE

Instructor of Biology, NYU Abu Dhabi

ILYA SPITKOVSKY

Professor of Mathematics, NYU Abu Dhabi

JAN LOOP

Professor of Early Modern History and Religious Cultures, NYU Abu Dhabi

JEMIMA A. FRIMPONG

Associate Professor of Social Research and Public Policy, NYU Abu Dhabi

JOAN BARCELÓ

Assistant Professor of Political Science, NYU Abu Dhabi

JOERG BLUMTRITT

Visiting Assistant Professor of Practice of Interactive Media, Creative Technologist, NYU Abu Dhabi

JOHN BURT

Associate Professor of Biology, NYU Abu Dhabi

JONATHAN ANDREW HARRIS

Assistant Professor of Political Science, NYU Abu Dhabi

JOO H. KIM

Associate Professor of Mechanical and Aerospace Engineering, NYU Tandon School of Engineering, NYU New York

JUSTIN WILCOX

Postdoctoral Associate, The Center for Genomics and Systems Biology (CGSB), NYU Abu Dhabi

KARTIK SREENIVASAN

Assistant Professor of Psychology, NYU Abu Dhabi

KEMAL CELIK

Assistant Professor of Civil and Urban Engineering, NYU Abu Dhabi

KHALIL RAMADI

Assistant Professor of Bioengineering, NYU Abu Dhabi

KINGA MAKOVI

Assistant Professor of Social Research and Public Policy, NYU Abu Dhabi

KIRSTEN SADLER EDEPLI

Vice Provost, Faculty Advancement and Engagement; Professor of Biology, NYU Abu Dhabi

K. R. SREENIVASAN

Principal Investigator, Center for Space Science, NYU Abu Dhabi

LEONID KUZMENKO

Composer, Music and Sound Cultures (MaSC), NYU Abu Dhabi

MAHMOUD RASRAS

Associate Professor of Electrical Engineering, NYU Abu Dhabi

MARK SWISLOCKI

Program Head, History; Associate Professor of History, NYU Abu Dhabi

MARTIN KLIMKE

Vice Provost; Acting Program Head, Literature & Creative Writing; Associate Professor of History, NYU Abu Dhabi

MARZIA BALZANI

Program Head, Anthropology; Research Professor of Anthropology, NYU Abu Dhabi

MAURIZIO PORFIRI

Institute Professor of Mechanical and Aerospace Engineering, Biomedical Engineering; Associate Faculty for Civil and Urban Engineering; Core Faculty for the Center for Urban Science and Progress (CUSP), NYU Tandon School of Engineering, NYU New York

MAY AL-DABBAGH

Assistant Professor of Social Research and Public Policy, NYU Abu Dhabi

MAZIN MAGZOUB

Associate Professor of Biology, NYU Abu Dhabi

MELANIE MENG XUE

Assistant Professor of Economics, NYU Abu Dhabi

MOHAMAD EID

Assistant Professor of Electrical and Computer Engineering, NYU Abu Dhabi

MORGAN HARDY

Assistant Professor of Economics, NYU Abu Dhabi

MUHAMED OSMAN AL-KHALIL

Associate Professor of Practice of Arabic Language, NYU Abu Dhabi

MUHAMMAD SHAFIQUE

Associate Professor of Computer Engineering, NYU Abu Dhabi

NANCY GLEASON

Associate Professor of Practice of Political Science; Director, Hilary Ballon Center for Teaching and Learning, NYU Abu Dhabi

NIZAR HABASH

Professor of Computer Science, NYU Abu Dhabi

OLIVIA CHEUNG

Assistant Professor of Psychology, NYU Abu Dhabi

ONOSO IMOAGENE

Associate Professor of Social Research and Public Policy, NYU Abu Dhabi

PANČE NAUMOV

Professor of Chemistry, NYU Abu Dhabi

PHILIP PANICKER

Senior Lecturer, Mechanical Engineering, NYU Abu Dhabi

PIERGIORGIO PERCIPALLE

Associate Dean for Research and Graduate Programs, Science Division; Program Head, Biology; Associate Professor of Biology, NYU Abu Dhabi

RIYADH BAGHDADI

Assistant Professor of Computer Science, NYU Abu Dhabi

ROBERT PARTHESIUS

Program Head, Heritage Studies; Associate Professor of Heritage Studies, NYU Abu Dhabi

SAIF JABARI

Associate Professor of Civil and Urban Engineering, NYU Abu Dhabi

SALWA MIKDADI

Professor of Practice of Art History, NYU Abu Dhabi

SAQER ALMARRI

Humanities Research Fellow, NYU Abu Dhabi

SOHMYUNG HA

Assistant Professor of Electrical Engineering and Bioengineering, NYU Abu Dhabi

SOPHIA KALANTZAKOS

Global Distinguished Professor, Environmental Studies and Public Policy, NYU New York and NYU Abu Dhabi

STÉPHANE BOISSINOT

Professor of Biology, NYU Abu Dhabi

SURABHI SHARMA

Program Head, Film and New Media; Associate Professor of Practice of Film and New Media, NYU Abu Dhabi

TANELI KUKKONEN

Professor of Philosophy, NYU Abu Dhabi

VIJAYAVENKATARAMAN SANJAIRAJ

Assistant Professor of Mechanical Engineering and Bioengineering, NYU Abu Dhabi

YI FANG

Associate Professor of Computer Engineering, NYU Abu Dhabi

YONG-AK (RAFAEL) SONG

Program Head, Bioengineering; Associate Professor of Mechanical Engineering and Bioengineering, NYU Abu Dhabi

YOUSSEF IDAGHDOUR

Assistant Professor of Biology, NYU Abu Dhabi

جامعة نيويورك أبوظبي



Office of Undergraduate Research
at NYUAD Abu Dhabi

Saadiyat Island, PO Box 129188

nyuad.nyu.edu/undergrad-research